

Features

- High Efficiency (Up to 89.5%)
- Full Power at Wide Output Current Range (Constant Power)
- Thermal Sensing and Protection for LED Module
- DALI/AC Dim/Timer Dimmable (3 Timer Modes)
- Dim-to-Off with Standby Power ≤ 0.5 W
- Always-on Auxiliary Power: 12Vdc, 200mA (Transient Peak Current up to 400mA)
- Output Lumen Compensation
- Long Lifetime Over 90K Hours at 75°C Case Temperature
- Input Surge Protection: DM 6kV, CM 10kV
- All-Around Protection: OVP, SCP, OTP,
- IP20 Design and Suitable for Outdoor Applications in Luminaires with IP>54
- SELV Output
- Suitable for Luminaires with Protection Class I and II
- Complies with Zhaga Interface Specification Book 13
- 7 Years Warranty



Description

The EBS-040SxxxBTE series is a 40W, constant-current, programmable LED driver that operates from 176-305 Vac input with excellent power factor. Created for many lighting applications including street, tunnel and low bay, it provides a dim-to-off mode with low standby power. The high efficiency of these drivers and better thermal design enable them to run cooler, significantly improving reliability and extending product life. To ensure trouble-free operation, protection is provided against input surge, output over voltage, short circuit, and over temperature of both the driver and the external LED array.

Models

Adjustable Output Current Range	Full-Power Current Range (1)	Default Output Current	Input Voltage Range(2)	Output Voltage Range	Max. Output Power	Typical Efficiency (3)	Typical Power Factor (3)	Model Number (4)
45-700 mA	450-700 mA	700 mA	176~305 Vac 190~250 Vdc	28~89 Vdc	40 W	89.5%	0.96	EBS-040S070BTE
70-1050mA	700-1050 mA	1050 mA	176~305 Vac 190~250 Vdc	19 ~57Vdc	40 W	89.5%	0.96	EBS-040S105BTE

- Notes:** (1) Output current range with constant power at 40W
 (2) Certified voltage range: 200-240Vac or 190-250Vdc (except CCC and KS)
 (3) Measured at 100% load and 220Vac input (see below "General Specifications" for details).
 (4) SELV Output.

I-V Operating Area

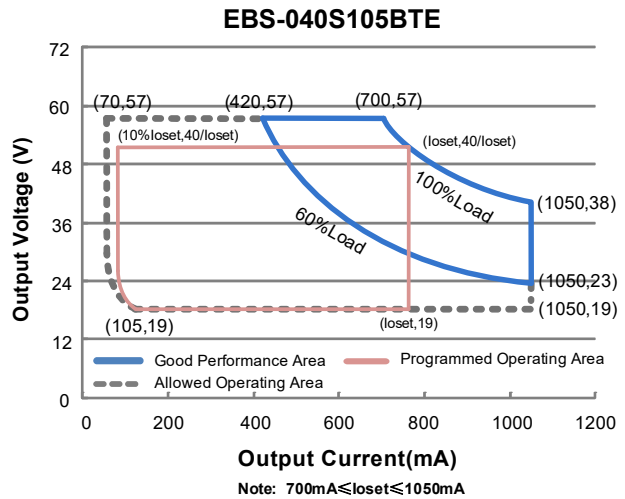
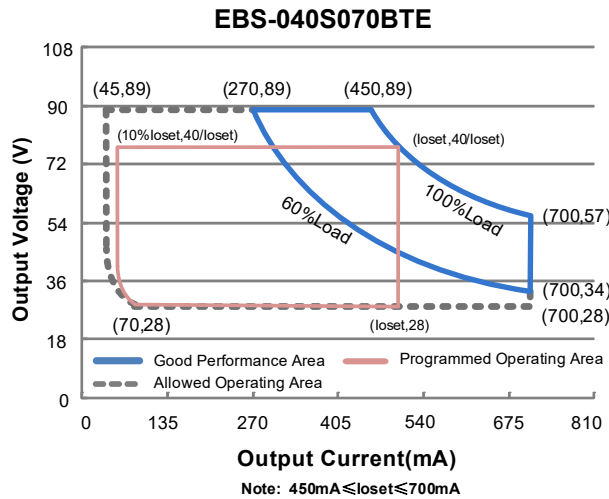

Input Specifications

Parameter	Min.	Typ.	Max.	Notes
Input AC Voltage	176 Vac	-	305 Vac	
Input DC Voltage	190 Vdc	-	250 Vdc	
Input Frequency	47 Hz	-	63 Hz	
Leakage Current	-	-	0.70 mA	IEC 60598-1; 240Vac/ 60Hz
Input AC Current	-	-	0.30 A	Measured at 100% load and 220 Vac input.
Inrush Current(I ² t)	-	-	0.35 A ² s	At 220Vac input, 25°C Cold Start, Duration =368 μs, 10%Ipk-10%Ipk. See Inrush Current Waveform for the details.
PF	0.90	-	-	At 200-240Vac, 50-60Hz, 60%-100% Load (24-40W)
THD	-	-	20%	
THD	-	-	10%	At 220-240Vac, 50-60Hz, 70%-100% Load (28-40W)

Output Specifications

Parameter	Min.	Typ.	Max.	Notes
Output Current Tolerance	-5%I _{load}	-	5%I _{load}	At 100% load condition
Output Current Setting (I _{load}) Range				
EBS-040S070BTE	45 mA	-	700 mA	
EBS-040S105BTE	70 mA	-	1050 mA	
Output Current Setting Range with Constant Power				
EBS-040S070BTE	450 mA	-	700 mA	
EBS-040S105BTE	700 mA	-	1050 mA	
Total Output Current Ripple (pk-pk)	-	5%I _{load} max	10%I _{load} max	At 100% load condition, 20 MHz BW

Output Specifications (Continued)

Parameter	Min.	Typ.	Max.	Notes
Output Current Ripple at < 200 Hz (pk-pk)	-	2%I _{omax}	-	At 100% load condition. Only this component of ripple is associated with visible flicker.
Startup Overshoot Current	-	-	10%I _{omax}	At 100% load condition
No Load Output Voltage EBS-040S070BTE EBS-040S105BTE	- -	- -	119 V 68 V	
Line Regulation	-	-	±0.5%	Measured at 100% load
Load Regulation	-	-	±1.5%	
Turn-on Delay Time	-	-	0.5 s	Measured at 220Vac input, 60%-100% Load
Temperature Coefficient of I _o set	-	0.04%/°C	-	Case temperature = 0°C ~T _c max
12V Auxiliary Output Voltage	10.8 V	12 V	13.2 V	
12V Auxiliary Output Source Current	0 mA	-	200 mA	Return terminal is "Return"
12V Auxiliary Output Transient Peak Current	-	-	400 mA	400mA peak for a maximum duration of 300ms in a 2s period during which time the average should not exceed 200mA.

General Specifications

Parameter	Min.	Typ.	Max.	Notes
Efficiency at 220 Vac input: EBS-040S070BTE I _o = 450 mA I _o = 700 mA EBS-040S105BTE I _o = 700 mA I _o = 1050 mA	87.5% 87.0%	89.5% 89.0%	- -	Measured at 100% load and steady-state temperature in 25°C ambient; (Efficiency will be about 2.0% lower if measured immediately after startup.)
Standby Power	-	-	0.5 W	Measured at 230Vac/50Hz; Dimming off
MTBF	-	340,000 hours	-	Measured at 220Vac input, 80% Load and 25°C ambient temperature (MIL-HDBK-217F)
Lifetime	-	93,000 hours	-	Measured at 220Vac input, 80%Load and 75°C case temperature; See lifetime vs. T _c curve for the details
Operating Case Temperature for Safety T _{c_s}	-40°C	-	+90°C	
Operating Case Temperature for Warranty T _{c_w}	-40°C	-	+75°C	Case temperature for 7 years warranty. Please see Inventronics Warranty Statement for complete details. No condensation
Storage Temperature	-40°C	-	+85°C	Humidity: 5%RH to 85%RH; No condensation.
Dimensions Inches (L × W × H) Millimeters (L × W ×H)	4.85 x 3.12 x 1.30 123 x 79 x 33			
Net Weight	-	220 g	-	

Dimming Specifications

Parameter		Min.	Typ.	Max.	Notes
DALI	DA, DA High Level	9.5 V	16 V	22.5 V	
	DA, DA Low Level	-6.5 V	0 V	6.5 V	
	DA, DA Current	0 mA	-	2 mA	
AC Dim	Start Input Voltage	180 Vac	-	250 Vac	Default is 220 Vac
	Start Output Level	30%	-	100%	Default is 100%
	Stop Input Voltage	160 Vac	-	230 Vac	Default is 170 Vac
	Stop Output Level	30%	-	85%	Default is 30%
	Gap between Start and Stop Input Voltage	20 Vac	-	-	
	Increment of Start and Stop Input Voltage	-	1 Vac	-	
	Increment of Start and Stop Output Level	-	1%	-	
Dimming Output Range	EBS-040S070BTE EBS-040S105BTE	10%loset	-	loset	450 mA ≤ loiset ≤ 700 mA 700 mA ≤ loiset ≤ 1050 mA
	EBS-040S070BTE EBS-040S105BTE	45 mA 70 mA	-	loiset	45 mA ≤ loiset < 450 mA 70 mA ≤ loiset < 700 mA

Safety & EMC Compliance

Safety Category	Standard
ENEC & CE	EN 61347-1, EN61347-2-13
CB	IEC 61347-1, IEC 61347-2-13
CCC	GB 19510.1, GB 19510.14
KS	KS C 7655
Performance	Standard
ENEC	EN IEC 62384
EMI Standards	Notes
EN IEC 55015/GB/T 17743 ⁽¹⁾	Conducted emission Test & Radiated emission Test
EN IEC 61000-3-2/GB 17625.1	Harmonic current emissions Class C
EN 61000-3-3	Voltage Fluctuations & Flicker
EMS Standards	Notes
EN 61000-4-2	Electrostatic Discharge(ESD): 8 kV air discharge, 4 kV contact discharge
EN 61000-4-3	Radio-Frequency Electromagnetic Field Susceptibility Test-RS

Safety & EMC Compliance (Continued)

EMS Standards	Notes
EN 61000-4-4	Electrical Fast Transient/Burst-EFT
EN 61000-4-5	Surge Immunity Test: AC Power Line: Differential Mode 6 kV, Common Mode 8 kV
EN 61000-4-6	Conducted Radio Frequency Disturbances Test-CS
EN 61000-4-8	Power Frequency Magnetic Field Test
EN 61000-4-11	Voltage Dips
EN 61547	Surge Immunity Test: AC Power Line: Differential Mode 6 kV, Common Mode 10 kV
	Electromagnetic Immunity Requirements Applies to Lighting Equipment
DALI Standards	Notes
DALI	IEC62386-101,102 & part of 207 ⁽²⁾

Notes: (1) This LED driver meets the EMI specifications above, but EMI performance of a luminaire that contains it depends also on the other devices connected to the driver and on the fixture itself.
 (2) Optional Commands Implemented: 242 (query short circuit), 243 (query open circuit).

Lifetime vs. Case Temperature

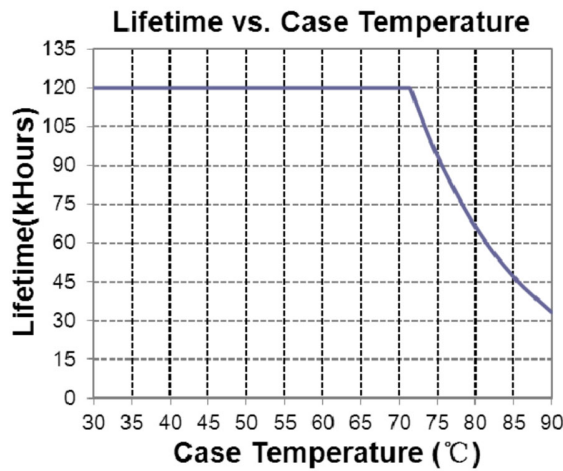

Inrush Current Waveform

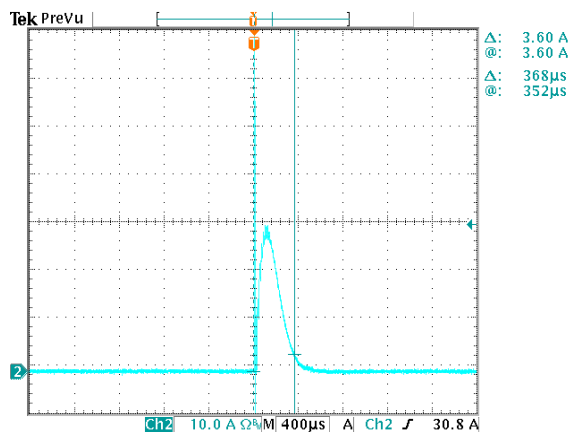

Efficiency vs. Load

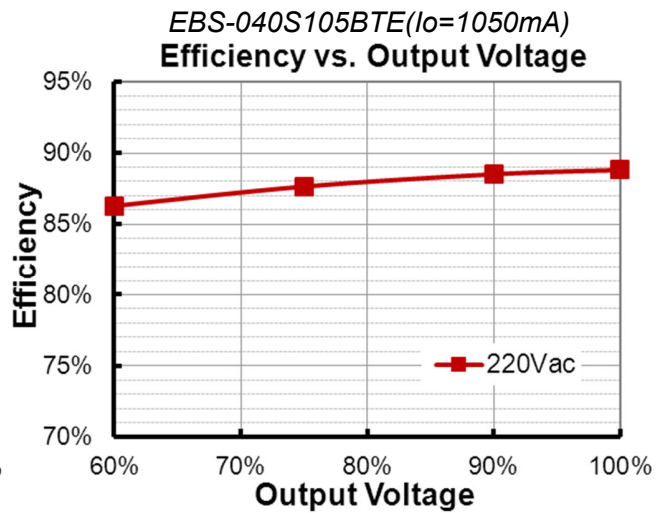
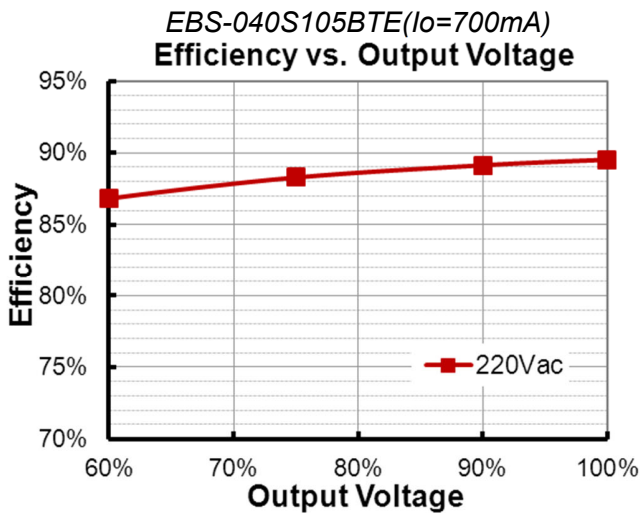
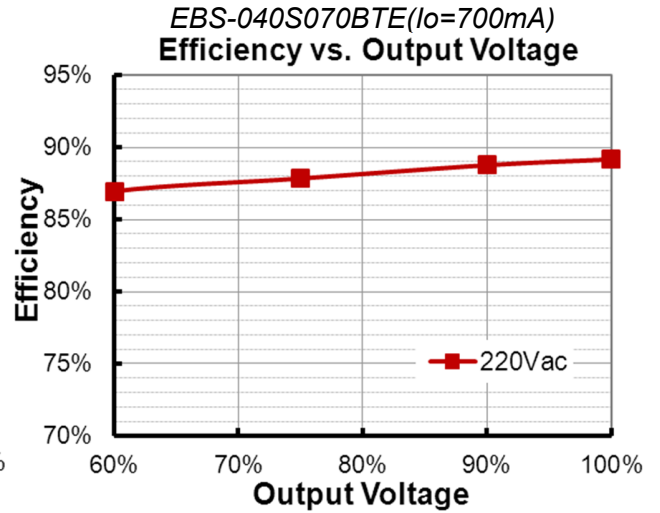
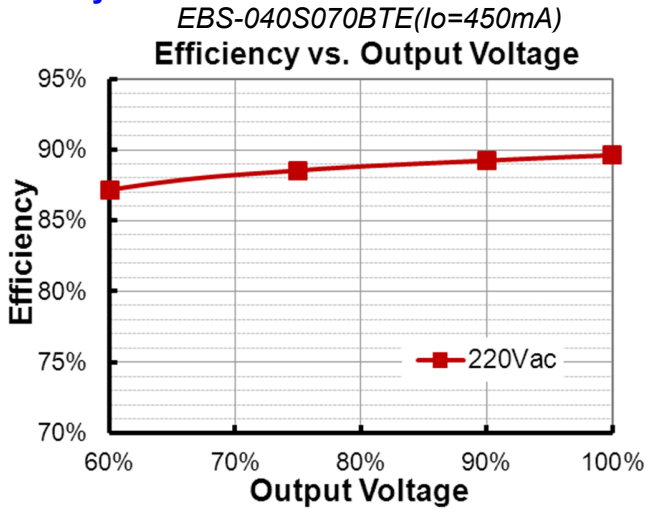

Power Factor

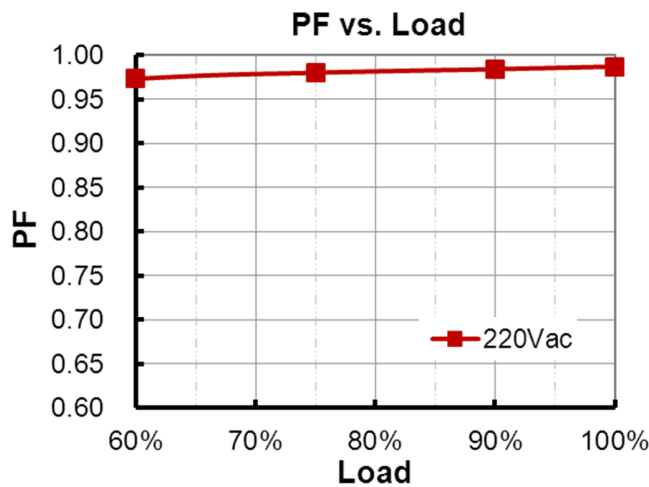

Total Harmonic Distortion

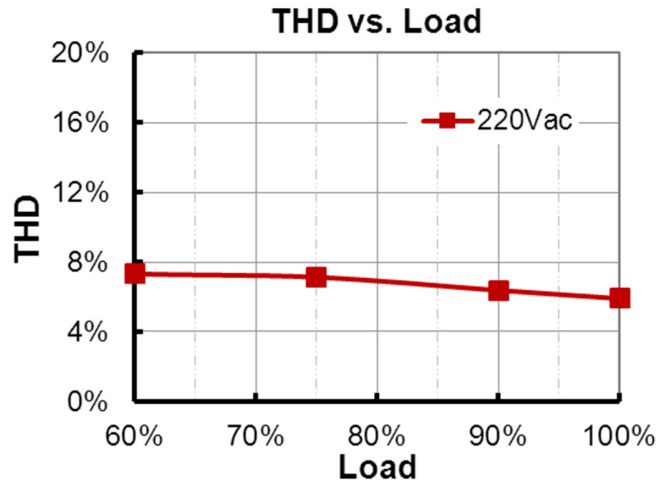

Protection Functions

Parameter		Min.	Typ.	Max.	Notes
External Thermal Protection NTC	R1	-	7.81 kOhm	-	When R_NTC falls below R1, External Thermal Protection is triggered, reducing output current until R2 is reached.
	R2	-	4.16 kOhm	-	When R_NTC is less than R2, output current is reduced to the programmed "Protection Current Floor."
	Protection Current Floor	10%loset	60%loset	100%loset	10%loset > Iomin (default setting is 60%)
		Iomin	60%loset	100%loset	10%loset ≤ Iomin (default setting is 60%)
Over Temperature Protection		Decreases output current, returning to normal after over temperature is removed.			
Short Circuit Protection		Auto Recovery. No damage will occur when any output is short circuited. The output shall return to normal when the fault condition is removed.			
Over Voltage Protection		Limits output voltage at no load and in case the normal voltage limit fails.			

Dimming

● DALI Dimming

The recommended implementation of the dimming control is provided below.

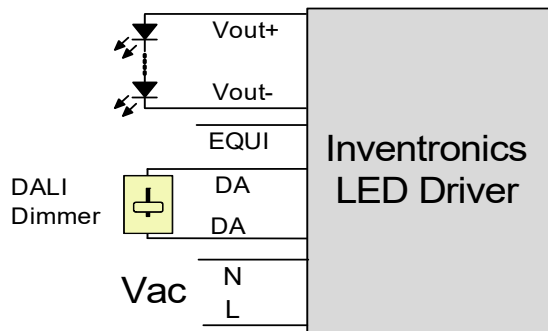

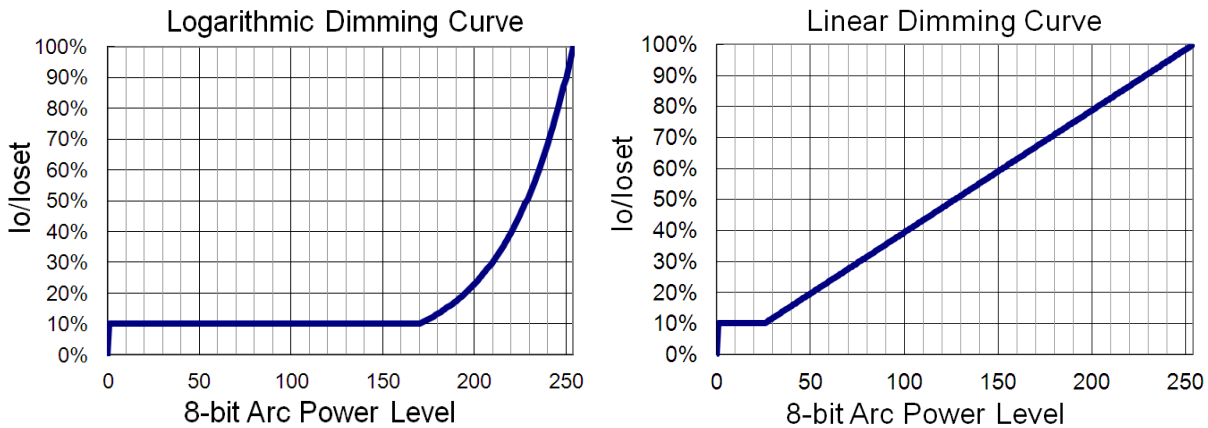

Implementation: DALI Dimming

● **Time Dimming**

Time dimming control includes 3 kinds of modes, they are Self Adapting-Midnight, Self Adapting-Percentage and Traditional Timer.

- **Self Adapting-Midnight:** Automatically adjusts the dimming curve based on the on-time of past two days (if difference <15 minutes), assuming that the center point of the dimming curve is midnight local time.
- **Self Adapting-Percentage:** Automatically adjusts the on-time of each step by a constant percentage = (actual on-time for the past 2 days if difference <15 min) / (programmed on-time from the dimming curve).
- **Traditional Timer:** Follows the programmed timing curve after power on with no changes.

● **AC Dimming**

The default range of AC Dim is 160-250Vac. The range can be adjusted via the programming interface. Also, the Start Input Voltage, Start Output Level, Stop Input Voltage and Stop Output Level can be set. There needs to be a minimum of 20V difference between Start and Stop Input Voltage settings when programming the driver.

There must be a minimum voltage difference of 5V from the Start Input Voltage before the driver starts dimming.

Output Level

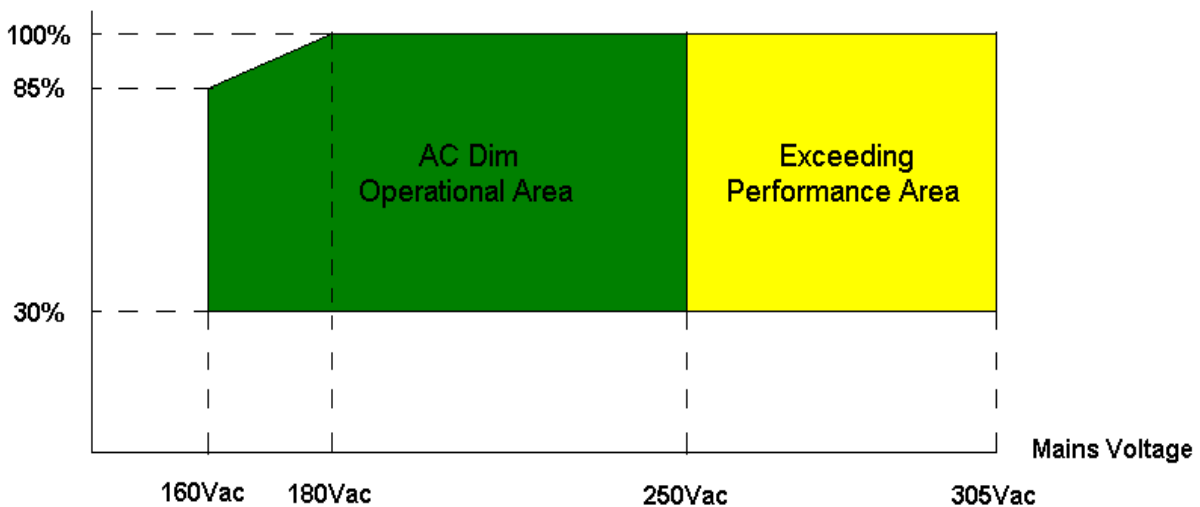

Notes:

1. In the green area, the driver will operate normally.
2. In the yellow area, the driver will operate safely but not fulfill requirements.

● **Output Lumen Compensation**

Output Lumen Compensation (OLC) may be used to maintain constant light output over the life of the LEDs by driving them at a reduced current when new, then gradually increasing the drive current over time to counteract LED lumen degradation.

Wire Connection Diagram

Parameter		Min.	Typ.	Max.	Notes
L, N, EQUI	Wire Cross-section	0.4 mm ²	-	1.5 mm ²	Push-in at 45° angle, solid and stranded wire
		20 AWG	-	16 AWG	
	Strip Length	8.5 mm	-	9.5 mm	
Vout+, Vout-, Return, Tmon, +12V, DA, DA	Wire Cross-section	0.2 mm ²	-	1.5 mm ²	Push-in at 45° angle, solid and stranded wire
		22 AWG	-	16 AWG	
	Strip Length	8.5 mm	-	9.5 mm	

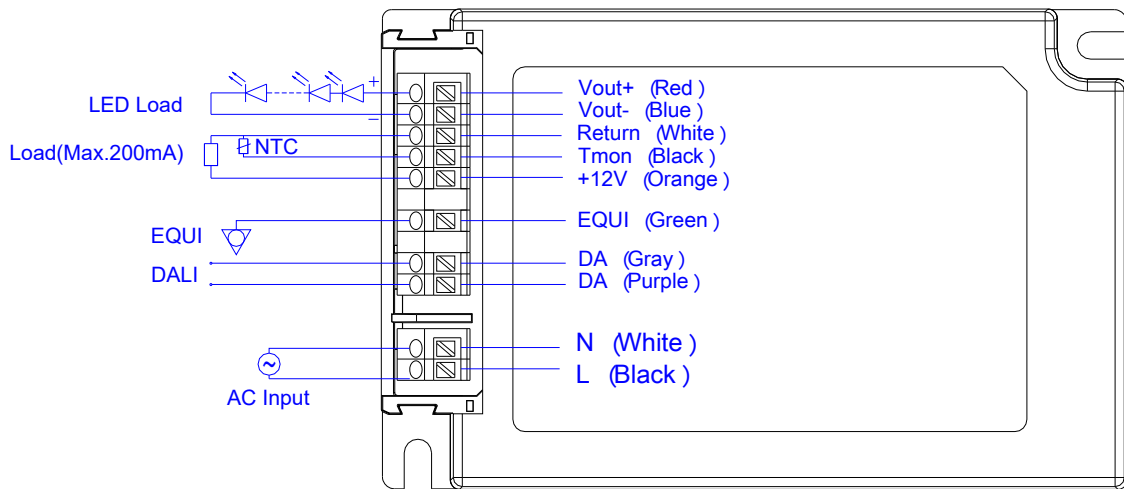

Programming Connection Diagram

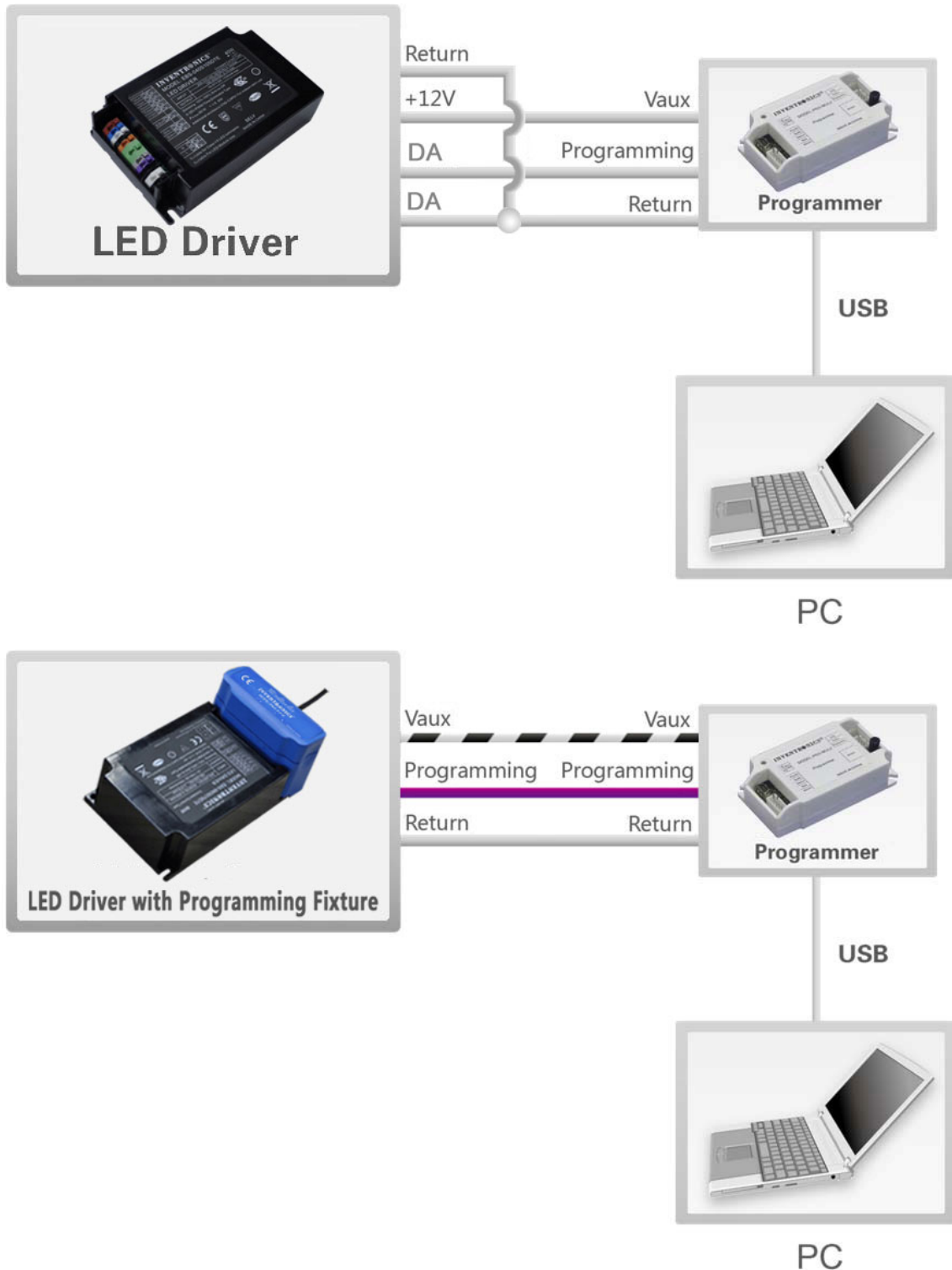

Note: The driver does not need to be powered on during the programming process.

- Please refer to [PRG-MUL2](#) (Programmer) and [PRG-FIX-E](#) (Programming Fixture) datasheet for details.

Mechanical Outline

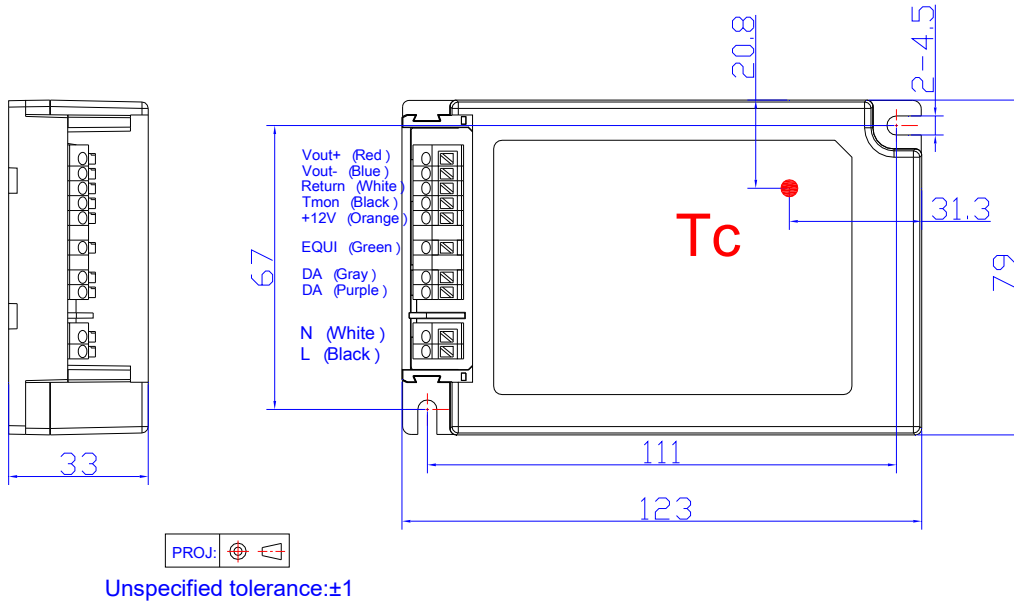

Optional Cable Clamp END-CAP01

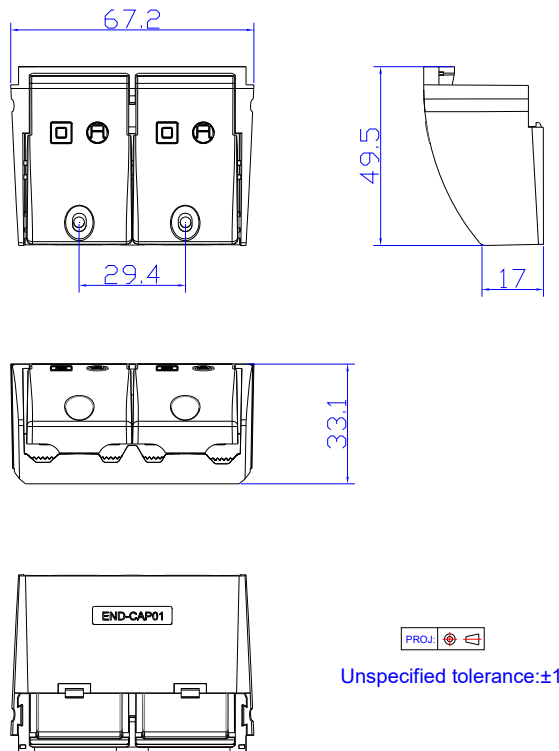

Note: The cable clamp is to be installed with EBS-040SxxxBTE drivers for independent application. Please refer to [END-CAP01](#) datasheet for details.

RoHS Compliance

Our products comply with reference to RoHS Directive (EU) 2015/863 amending 2011/65/EU, calling for the elimination of lead and other hazardous substances from electronic products.

Revision History

Change Date	Rev.	Description of Change		
		Item	From	To
2016-11-29	A	Datasheets Release	/	/
2017-10-24	B	Features	7 Years Warranty	Added
		Features	Always-on Auxiliary Power	Added
		Input Specifications	PF/THD	Updated
		Output Specifications	Temperature Coefficient of Isot	Updated
		Output Specifications	12V Auxiliary Output Transient Peak Current	Added
		General Specifications	Operating Case Temperature for Warranty Tc_w	Updated
2018-01-26	C	Description	/	Updated
		Operating Case Temperature for Warranty Tc_w	Notes	Updated
		Wire Connection Diagram	/	Updated
2018-11-14	D	CCC Logo	/	Updated
		Safety & EMC Compliance	/	Updated
		Programming Connection Diagram	/	Updated
2024-05-15	E	Product Photograph	/	Updated
		TUV logo	/	Deleted
		Safety & EMC Compliance	/	Updated
		RoHS Compliance	/	Updated