

Features

- Innovative Design with No Electrolytic Capacitors
- Ultra Long Lifetime: Greater than 100,000 hrs at 85°C Case Temperature
- Full Power at Wide Output Current Range (Constant Power)
- 0-10V/PWM/3-Timer-Modes Dimmable
- Dim-to-Off with Standby Power \leq 0.5W
- Always-on Auxiliary Power: 12Vdc, 200mA
- Thermal Sensing and Protection for LED Module
- Output Lumen Compensation
- Input Surge Protection: DM 6kV, CM 10kV
- All-Around Protection: OVP, SCP, OTP
- IP67
- SELV Output
- 10 Years Warranty



Description

The EUD-150SxxxDVL series is a novel 150W design that has removed the use of Electrolytic capacitors to extend lifetime at elevated temperatures. It is a constant-current, programmable LED driver that operates from 90-305Vac input with excellent power factor. Created for many lighting applications including high bay, tunnel and roadway, etc, it provides a dim-to-off mode with low standby power. The high efficiency of these drivers and compact metal case enables them to run cooler, significantly improving reliability and extending product life. To ensure trouble-free operation, protection is provided against input surge, output over voltage, short circuit, and over temperature of both the driver and the external LED array.

Models

Adjustable Output Current Range	Full-Power Current Range (1)	Default Output Current	Input Voltage Range(2)	Output Voltage Range	Max. Output Power	Typical Efficiency (3)	Typical Power Factor		Model Number (5)
							120Vac	220Vac	
45-700mA	450-700mA	530 mA	90~305Vac 127~250Vdc	117~333Vdc	150 W	93.0%	0.98	0.96	EUD-150S070DVL
70-1050mA	700-1050mA	700 mA	90~305Vac 127~250Vdc	75~214Vdc	150 W	93.0%	0.98	0.96	EUD-150S105DVL
140-2100mA	1400-2100mA	1400 mA	90~305Vac 127~250Vdc	38~107Vdc	150 W	92.5%	0.98	0.96	EUD-150S210DVL ⁽⁴⁾
245-3500mA	2450-3500mA	3150 mA	90~305Vac 127~250Vdc	22 ~ 61Vdc	150 W	92.0%	0.98	0.96	EUD-150S350DVL ⁽⁴⁾
385-5600mA	3850-5600mA	4200 mA	90~305Vac 127~250Vdc	14 ~ 39Vdc	150 W	91.0%	0.98	0.96	EUD-150S560DVL ⁽⁴⁾

- Notes:** (1) Output current range with constant power at 150W
 (2) Certified input voltage range: 100-240Vac or 127-250Vdc (except CCC and KS)
 (3) Measured at 100% load and 220Vac input (see below "General Specifications" for details).
 (4) SELV output.
 (5) All the models are certificated to KS, except EUD-150S070DVL

I-V Operating Area

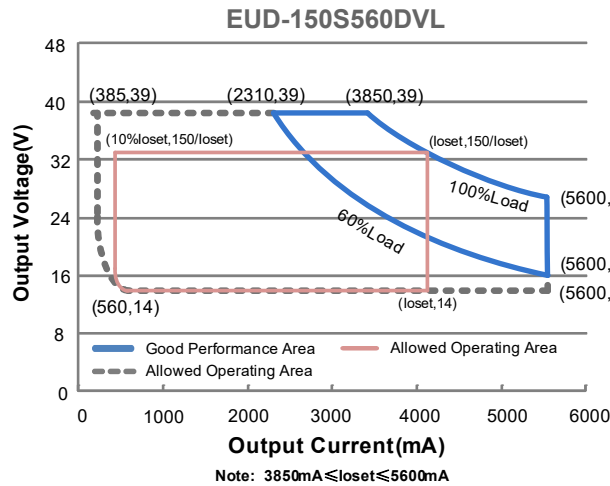
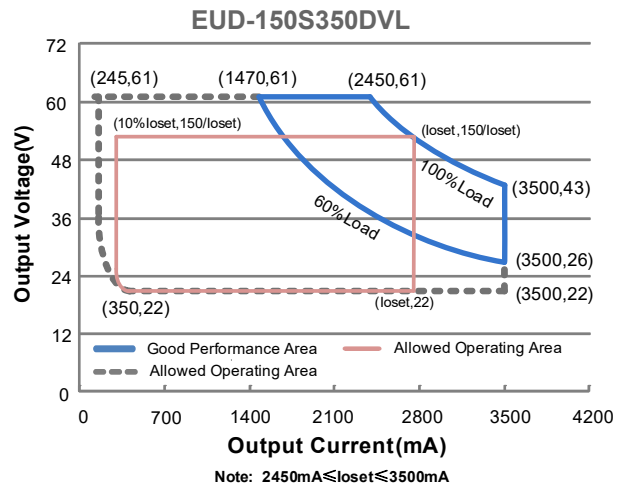
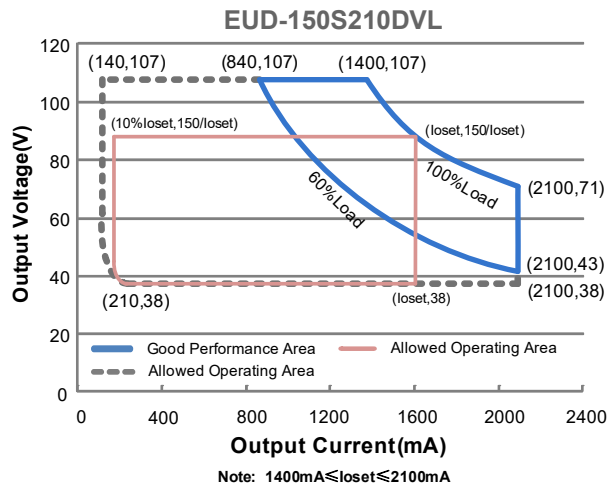
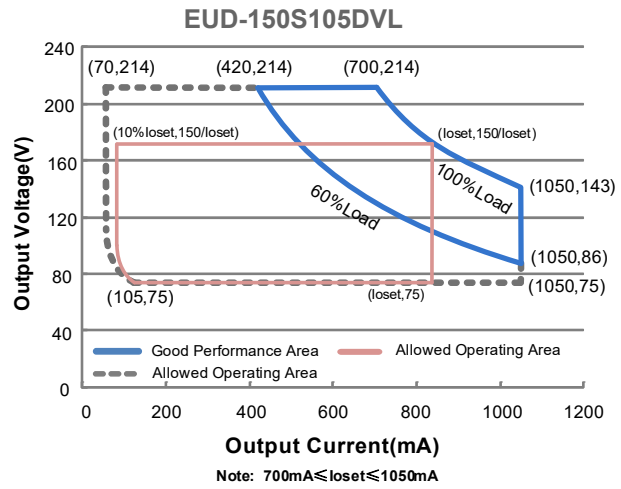
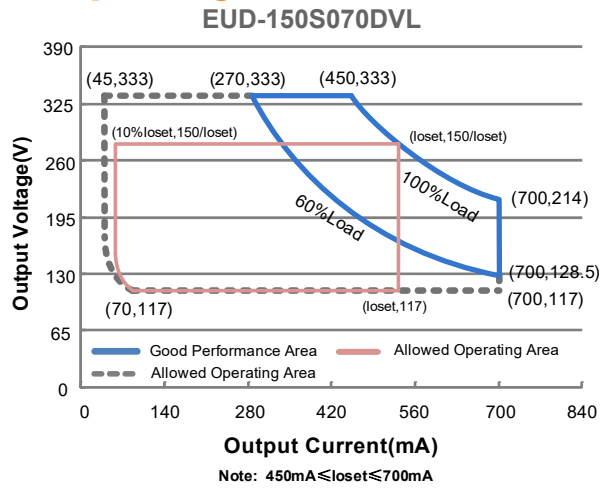

Input Specifications

Parameter	Min.	Typ.	Max.	Notes
Input AC Voltage	90 Vac	-	305 Vac	
Input DC Voltage	127 Vdc	-	250 Vdc	
Input Frequency	47 Hz	-	63 Hz	
Leakage Current	-	-	0.70 mA	IEC 60598-1; 240Vac/ 60Hz
Input AC Current	-	-	1.80 A	Measured at 100% load and 100 Vac input.
	-	-	0.80 A	Measured at 100% load and 220 Vac input.
Inrush Current(I ² t)	-	-	0.70 A ² s	At 220Vac input, 25°C Cold Start, Duration=432 μs, 10%I _{pk} -10%I _{pk} . See Inrush Current Waveform for the details.
PF	0.90	-	-	At 100-240Vac, 50-60Hz, 60%-100% Load (90-150W)
THD	-	-	20%	
THD	-	-	10%	At 220-240Vac, 50-60Hz, 75%-100% Load (112.5-150W)

Output Specifications

Parameter	Min.	Typ.	Max.	Notes
Output Current Tolerance	-5%loset	-	5%loset	At 100% load condition
Output Current Setting(loset) Range				
EUD-150S070DVL	45 mA	-	700 mA	
EUD-150S105DVL	70 mA	-	1050 mA	
EUD-150S210DVL	140 mA	-	2100 mA	
EUD-150S350DVL	245 mA	-	3500 mA	
EUD-150S560DVL	385 mA	-	5600 mA	
Output Current Setting Range with Constant Power				
EUD-150S070DVL	450 mA	-	700 mA	
EUD-150S105DVL	700 mA	-	1050 mA	
EUD-150S210DVL	1400 mA	-	2100 mA	
EUD-150S350DVL	2450 mA	-	3500 mA	
EUD-150S560DVL	3850 mA	-	5600 mA	
Total Output Current Ripple (pk-pk)	-	8%I _{omax}	15%I _{omax}	At 100% load condition, 20 MHz BW
Output Current Ripple at < 200 Hz (pk-pk)	-	2%I _{omax}	-	At 100% load condition. Only this component of ripple is associated with visible flicker.
Startup Overshoot Current	-	-	10%I _{omax}	At 100% load condition
No Load Output Voltage				
EUD-150S070DVL	-	-	350 V	
EUD-150S105DVL	-	-	230 V	
EUD-150S210DVL	-	-	117 V	
EUD-150S350DVL	-	-	68 V	
EUD-150S560DVL	-	-	46 V	
Line Regulation	-	-	±0.5%	Measured at 100% load

Output Specifications (Continued)

Parameter	Min.	Typ.	Max.	Notes
Load Regulation	-	-	± 1.5%	
Turn-on Delay Time	-	-	1.0 s	Measured at 120Vac input, 60%-100% Load
	-	-	0.5 s	Measured at 220Vac input, 60%-100% Load
Temperature Coefficient of I _o set	-	0.03%/°C	-	Case temperature = 0°C ~T _c max
12V Auxiliary Output Voltage	10.8 V	12 V	13.2 V	
12V Auxiliary Output Source Current	0 mA	-	200 mA	Return terminal is "Dim"

General Specifications

Parameter	Min.	Typ.	Max.	Notes
Efficiency at 120 Vac input:				
EUD-150S070DVL				
I _o = 450 mA	89.0%	91.0%	-	
I _o = 700 mA	87.5%	89.5%	-	
EUD-150S105DVL				
I _o = 700 mA	88.5%	90.5%	-	Measured at 100% load and steady-state temperature in 25°C ambient; (Efficiency will be about 2.0% lower if measured immediately after startup.)
I _o =1050 mA	87.5%	89.5%	-	
EUD-150S210DVL				
I _o =1400 mA	88.0%	90.0%	-	
I _o =2100 mA	86.5%	88.5%	-	
EUD-150S350DVL				
I _o =2450 mA	87.5%	89.5%	-	
I _o =3500 mA	86.0%	88.0%	-	
EUD-150S560DVL				
I _o =3850 mA	87.0%	89.0%	-	
I _o =5600 mA	85.0%	87.0%	-	
Efficiency at 220 Vac input:				
EUD-150S070DVL				
I _o = 450 mA	91.0%	93.0%	-	Measured at 100% load and steady-state temperature in 25°C ambient; (Efficiency will be about 2.0% lower if measured immediately after startup.)
I _o = 700 mA	90.0%	92.0%	-	
EUD-150S105DVL				
I _o = 700 mA	91.0%	93.0%	-	
I _o =1050 mA	90.0%	92.0%	-	
EUD-150S210DVL				
I _o =1400 mA	90.5%	92.5%	-	
I _o =2100 mA	89.0%	91.0%	-	
EUD-150S350DVL				
I _o =2450 mA	90.0%	92.0%	-	
I _o =3500 mA	88.5%	90.5%	-	
EUD-150S560DVL				
I _o =3850 mA	89.0%	91.0%	-	
I _o =5600 mA	87.0%	89.0%	-	

General Specifications (Continued)

Parameter	Min.	Typ.	Max.	Notes	
Efficiency at 277 Vac input: EUD-150S070DVL I _o = 450 mA I _o = 700 mA EUD-150S105DVL I _o = 700 mA I _o =1050 mA EUD-150S210DVL I _o =1400 mA I _o =2100 mA EUD-150S350DVL I _o =2450 mA I _o =3500 mA EUD-150S560DVL I _o =3850 mA I _o =5600 mA	91.5% 90.0%	93.5% 92.0%	- -	Measured at 100% load and steady-state temperature in 25°C ambient; (Efficiency will be about 2.0% lower if measured immediately after startup.)	
Standby power	-	-	0.5 W		Measured at 230Vac/50Hz; Dimming off
MTBF	-	240,000 Hours	-		Measured at 220Vac input, 80%Load and 25°C ambient temperature (MIL-HDBK-217F)
Lifetime	-	100,000 Hours	-		Measured at 220Vac input, 80%Load and 85°C case temperature; See lifetime vs. Tc curve for the details
Operating Case Temperature for Safety Tc_s	-40°C	-	+90°C		
Operating Case Temperature for Warranty Tc_w	-40°C	-	+75°C		Case temperature for 10 years warranty. Please see <i>Inventronics EUD-DVL Warranty Statement</i> for complete details.
Storage Temperature	-40°C	-	+85°C		Humidity: 5%RH to 100%RH
Dimensions Inches (L × W × H) Millimeters (L × W × H)	7.41 × 2.66 × 1.56 188 × 67.5 × 39.7				With mounting ear 8.23 × 2.66 × 1.56 209 × 67.5 × 39.7
Net Weight	-	1100 g	-		

Dimming Specifications

Parameter	Min.	Typ.	Max.	Notes	
Absolute Maximum Voltage on the Vdim (+) Pin	-20 V	-	20 V		
Source Current on Vdim (+) Pin	200 µA	300 µA	450 µA	Vdim(+) = 0 V	
Dimming Output Range	EUD-150S070DVL EUD-150S105DVL EUD-150S210DVL EUD-150S350DVL EUD-150S560DVL	10%I _o set	-	I _o set	450 mA ≤ I _o set ≤ 700 mA 700 mA ≤ I _o set ≤ 1050 mA 1400 mA ≤ I _o set ≤ 2100 mA 2450 mA ≤ I _o set ≤ 3500 mA 3850 mA ≤ I _o set ≤ 5600 mA
	EUD-150S070DVL EUD-150S105DVL EUD-150S210DVL EUD-150S350DVL EUD-150S560DVL	45 mA 70 mA 140 mA 245 mA 385 mA	-	I _o set	45 mA ≤ I _o set < 450 mA 70 mA ≤ I _o set < 700 mA 140 mA ≤ I _o set < 1400 mA 245 mA ≤ I _o set < 2450 mA 385 mA ≤ I _o set < 3850 mA

Dimming Specifications (Continued)

Parameter	Min.	Typ.	Max.	Notes
Recommended Dimming Input Range	0 V	-	10 V	Default 0-10V dimming mode.
Dim off Voltage	0.35 V	0.5 V	0.65 V	
Dim on Voltage	0.55 V	0.7 V	0.85 V	
Hysteresis	-	0.2 V	-	
PWM_in High Level	3 V	-	10 V	Dimming mode set to PWM in Inventronics programming software.
PWM_in Low Level	-0.3 V	-	0.6 V	
PWM_in Frequency Range	200 Hz	-	3 KHz	
PWM_in Duty Cycle	1%	-	99%	
PWM Dimming off (Positive Logic)	2%	5%	8%	
PWM Dimming on (Positive Logic)	4%	7%	10%	
PWM Dimming off (Negative Logic)	92%	95%	98%	
PWM Dimming on (Negative Logic)	90%	93%	96%	
Hysteresis	-	2%	-	

Safety & EMC Compliance

Safety Category	Standard
ENEC & CE	EN 61347-1, EN61347-2-13
CB	IEC 61347-1, IEC 61347-2-13
CCC	GB 19510.1, GB 19510.14
KS	KS C 7655
EMI Standards	Notes
EN IEC 55015/GB/T 17743 ⁽¹⁾	Conducted emission Test & Radiated emission Test
EN IEC 61000-3-2/GB 17625.1	Harmonic current emissions
EN 61000-3-3	Voltage fluctuations & flicker
EMS Standards	Notes
EN 61000-4-2	Electrostatic Discharge(ESD): 8kV air discharge, 4kV contact discharge
EN 61000-4-3	Radio-Frequency Electromagnetic Field Susceptibility Test-RS
EN 61000-4-4	Electrical Fast Transient/Burst-EFT
EN 61000-4-5	Surge Immunity Test: AC Power Line: Differential Mode 6 kV, Common Mode 10 kV ⁽²⁾

Safety & EMC Compliance (Continued)

EMS Standards	Notes
EN 61000-4-6	Conducted Radio Frequency Disturbances test-CS
EN 61000-4-8	Power Frequency Magnetic Field Test
EN 61000-4-11	Voltage Dips
EN 61547	Electromagnetic Immunity Requirements Applies To Lighting Equipment

- Note:** (1) This LED driver meets the EMI specifications above, but EMI performance of a luminaire that contains it depends also on the other devices connected to the driver and on the fixture itself.
- (2) To perform electric strength (hi-pot) testing, the “GDT ground disconnect” (nut and metal lock sheet) on the driver end-cap should be removed temporarily to prevent the internal gas discharge tube from conducting (as allowed by IEC 60598-1 Clause 10.2). After testing is completed, these items must be reinstalled to restore line-to-earth surge protection and secure the end cap.

Lifetime vs. Case Temperature

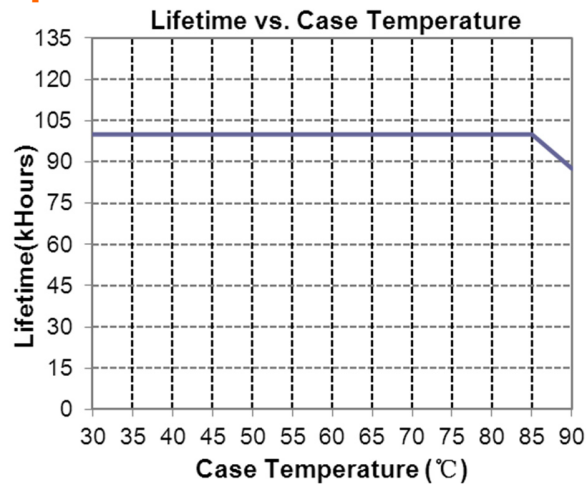

Inrush Current Waveform

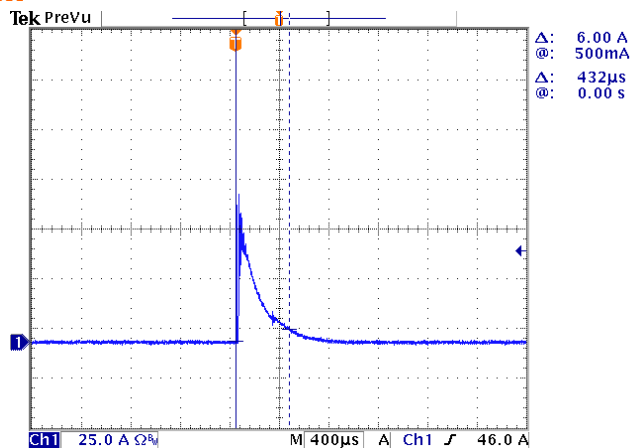

Efficiency vs. Load

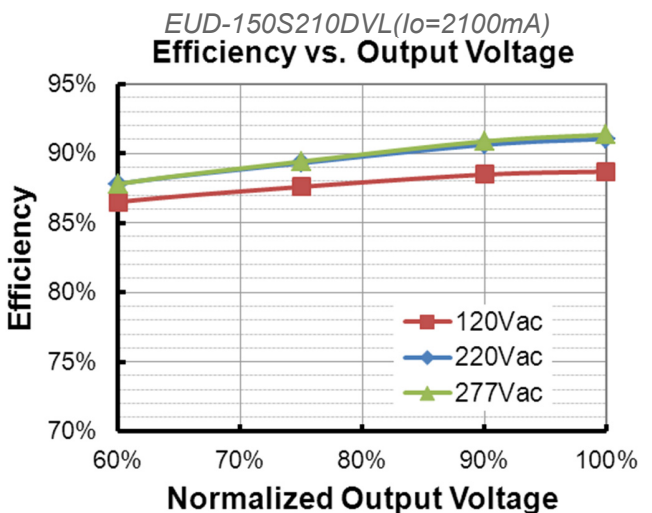
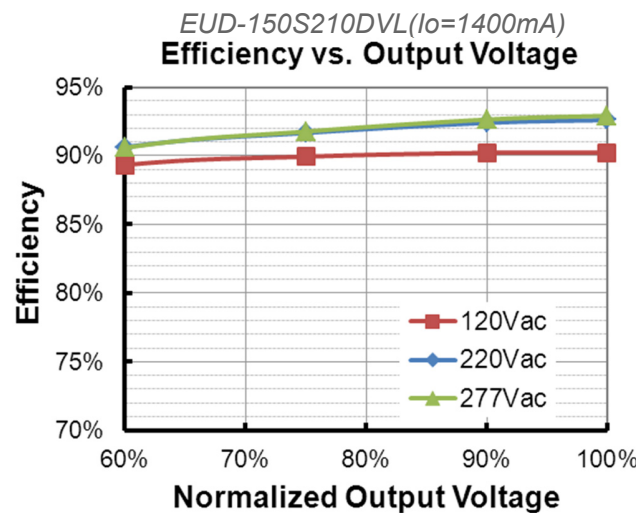
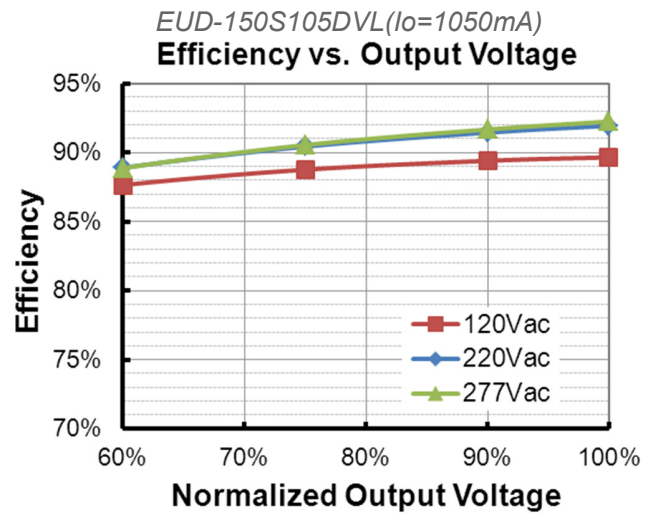
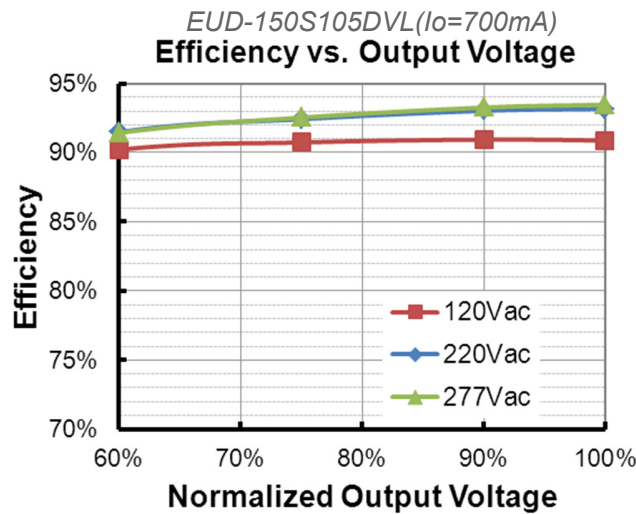
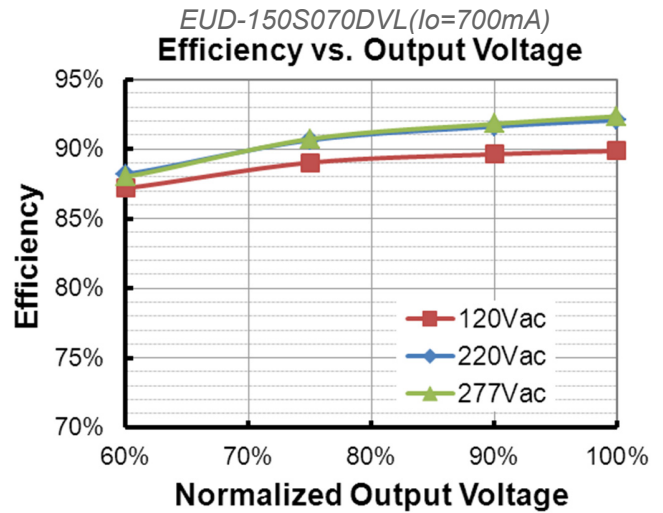
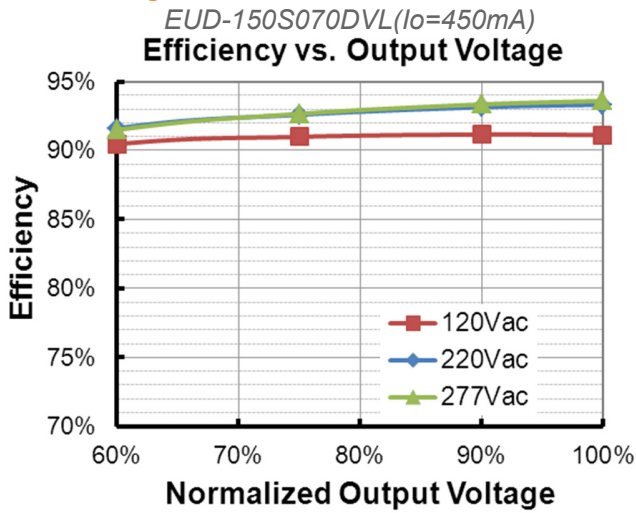

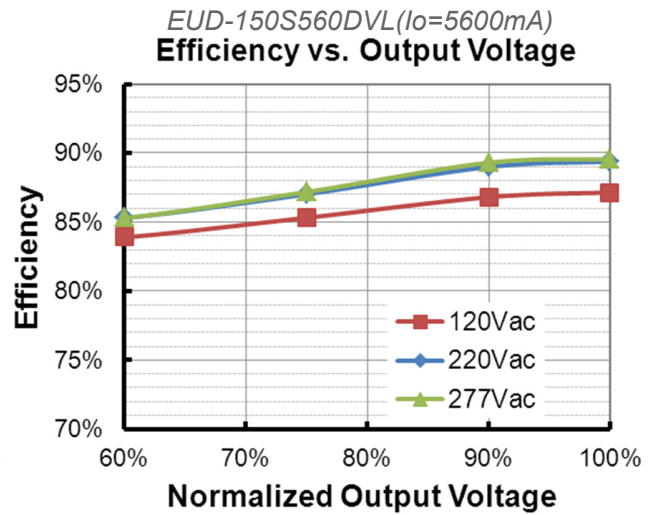
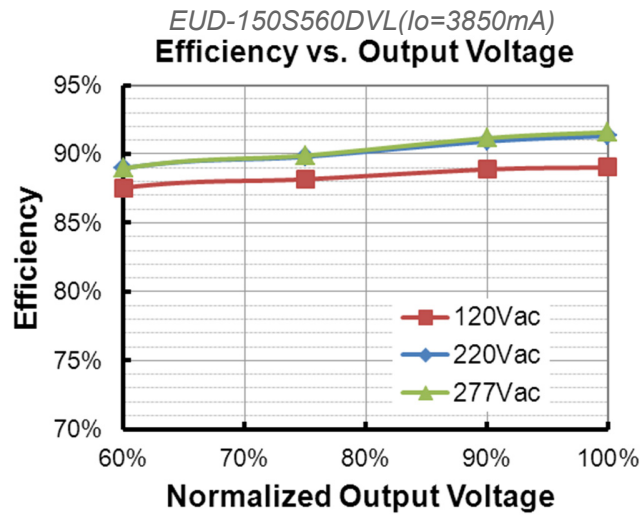
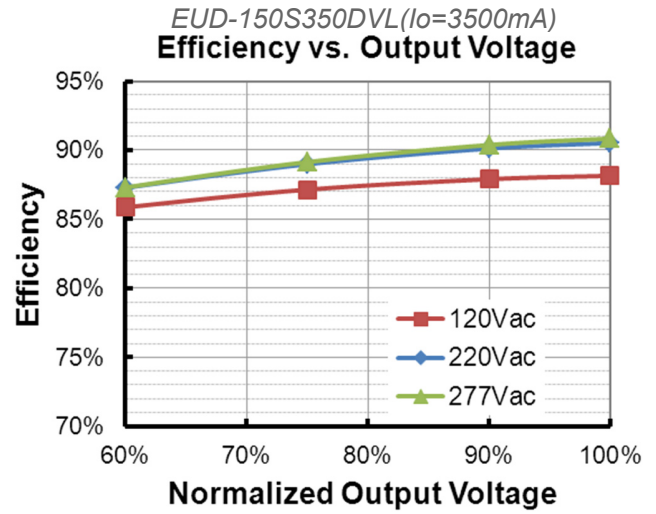
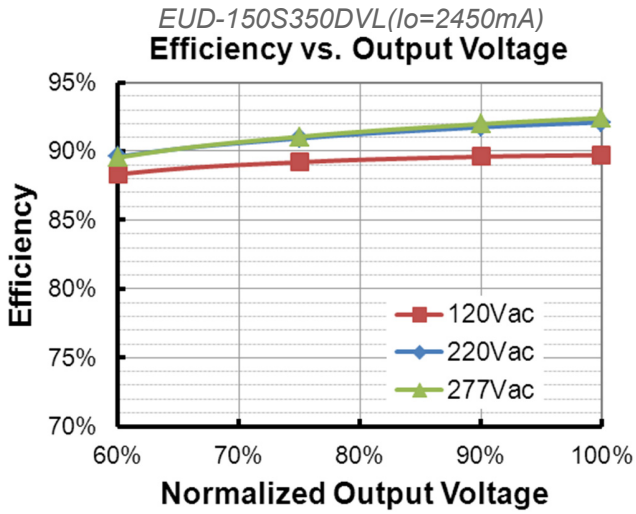

Power Factor

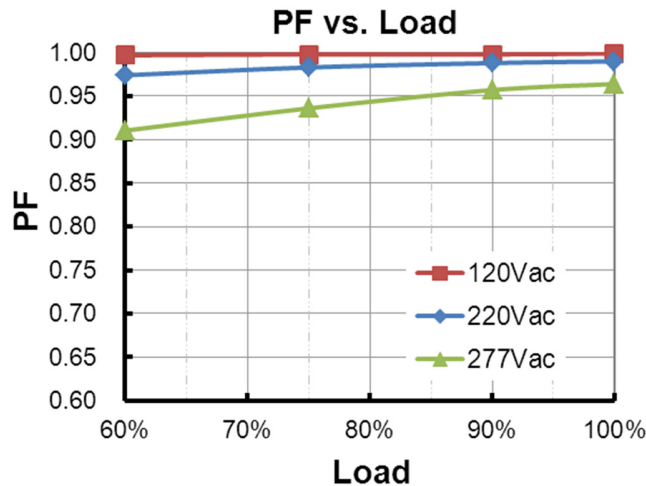

Total Harmonic Distortion

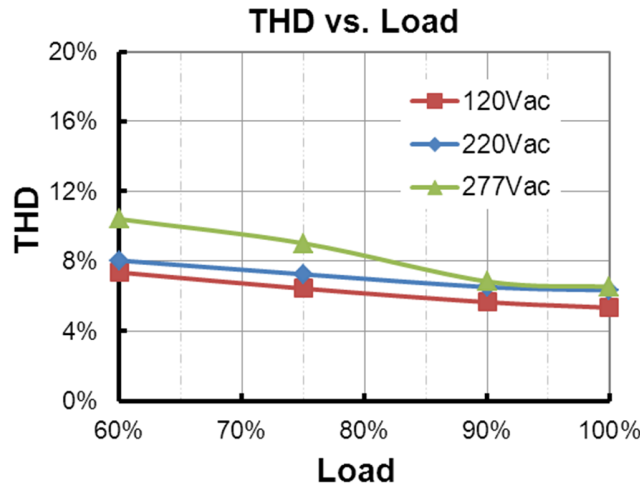

Protection Functions

Parameter		Min.	Typ.	Max.	Notes
External Thermal Protection NTC	R1	-	7.81 kOhm	-	When R_NTC falls below R1, External Thermal Protection is triggered, reducing output current until R2 is reached.
	R2	-	4.16 kOhm	-	When R_NTC is less than R2, output current is reduced to the programmed "Protection Current Floor."
	Protection Current Floor	10%I _{oSet}	60%I _{oSet}	100%I _{oSet}	10%I _{oSet} > I _{oMin} (default setting is 60%) 10%I _{oSet} ≤ I _{oMin} (default setting is 60%)
Over Temperature Protection		Decreases output current, returning to normal after over temperature is removed.			
Short Circuit Protection		Auto Recovery. No damage will occur when any output is short circuited. The output shall return to normal when the fault condition is removed.			
Over Voltage Protection		Limits output voltage at no load and in case the normal voltage limit fails.			

Dimming

● 0-10V Dimming

The recommended implementation of the dimming control is provided below

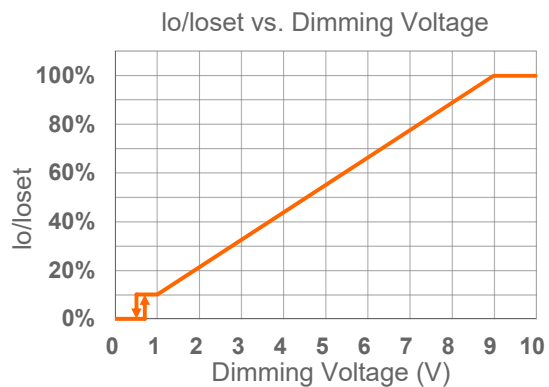
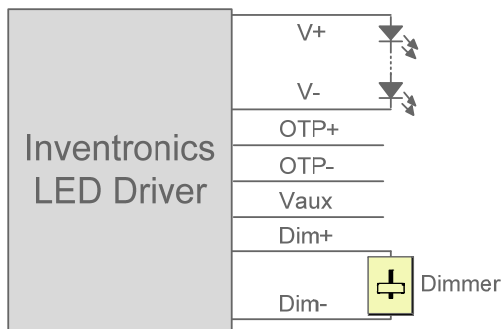

Implementation 1: DC Input

Notes:

1. Do NOT connect Dim- to the output V- or V+, otherwise the driver will not work properly.
2. The dimmer can also be replaced by an active 0-10V voltage source signal or passive components like zener.

● **PWM Dimming**

The recommended implementation of the dimming control is provided below.

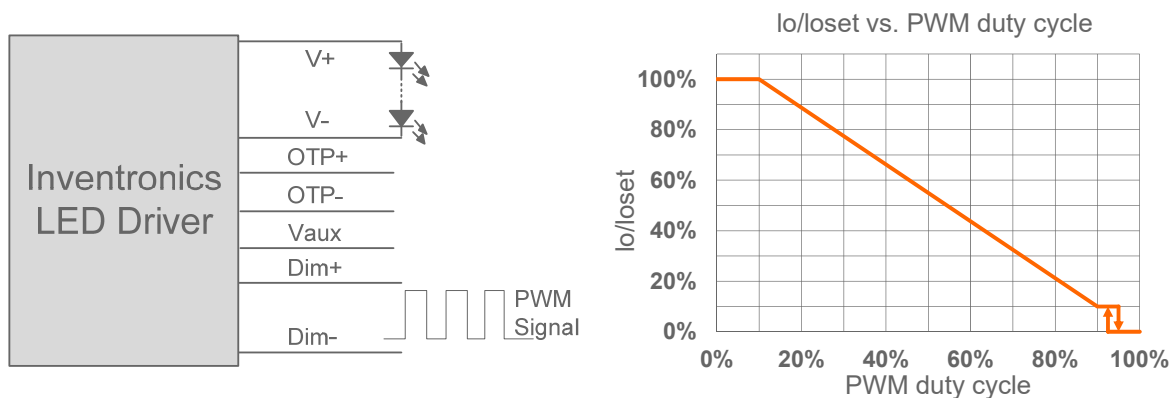
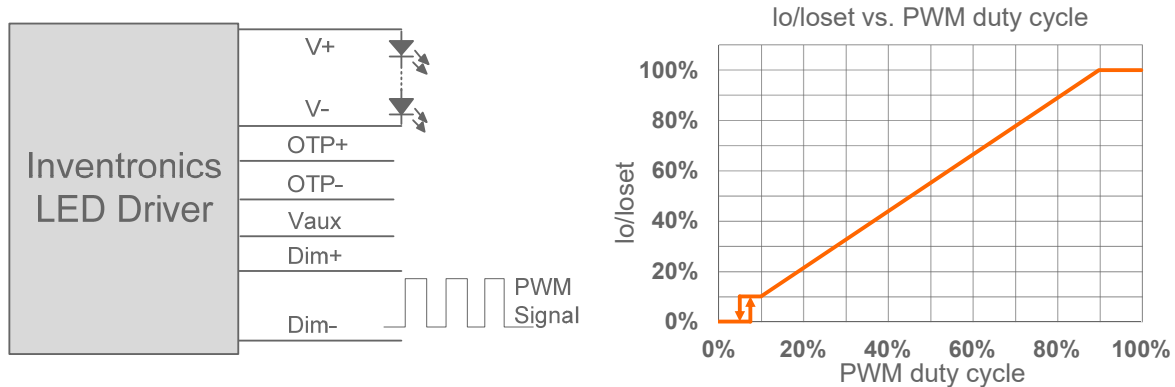

Notes:

1. Do NOT connect Dim- to the output V- or V+, otherwise the driver will not work properly.
2. When PWM negative logic dimming mode and Dim+ is open, the driver will dim to off and be standby.

● **Time Dimming**

Time dimming control includes 3 kinds of modes, they are Self Adapting-Midnight, Self Adapting-Percentage and Traditional Timer.

- **Self Adapting-Midnight:** Automatically adjusts the dimming curve based on the on-time of past two days (if difference <15 minutes), assuming that the center point of the dimming curve is midnight local time.
- **Self Adapting-Percentage:** Automatically adjusts the on-time of each step by a constant percentage = (actual on-time for the past 2 days if difference <15 min) / (programmed on-time from the dimming curve).
- **Traditional Timer:** Follows the programmed timing curve after power on with no changes.

● Output Lumen Compensation

Output Lumen Compensation (OLC) may be used to maintain constant light output over the life of the LEDs by driving them at a reduced current when new, then gradually increasing the drive current over time to counteract LED lumen degradation.

Programming Connection Diagram

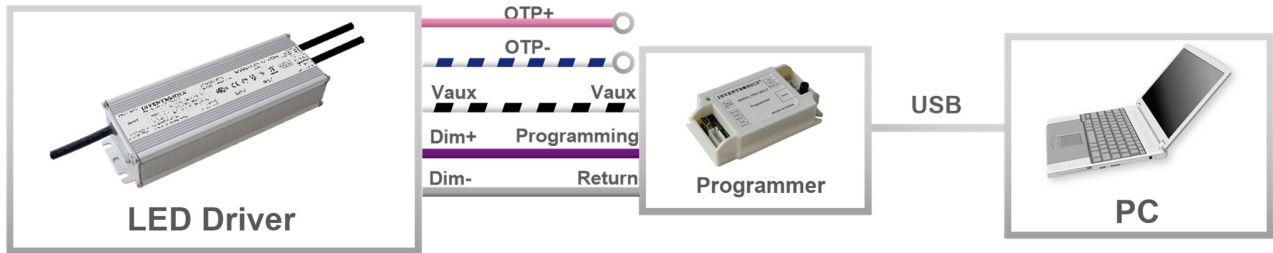

Note: The driver does not need to be powered on during the programming process.

● Please refer to [PRG-MUL2 Multi-Programmer](#) datasheet for details.

Mechanical Outline

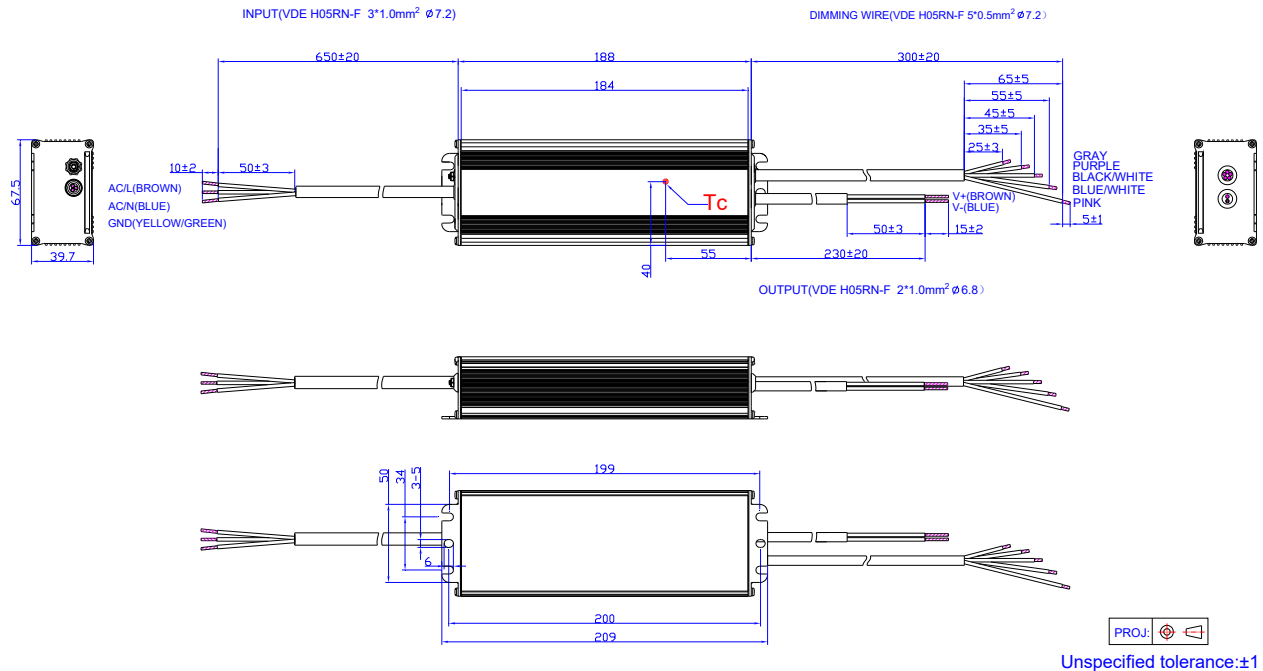

RoHS Compliance

Our products comply with reference to RoHS Directive (EU) 2015/863 amending 2011/65/EU, calling for the elimination of lead and other hazardous substances from electronic products.

Revision History

Change Date	Rev.	Description of Change		
		Item	From	To
2017-08-09	A	Datasheets Release	/	/
2019-10-24	B	ENEC Logo	/	Updated
		TUV Logo	/	Updated
		PSE Logo	/	Updated
		Independent Logo	/	Added
		Features	Timer Dimmable (3 Timer Modes)	3-Timer-Modes Dimmable
		Features	6kV line-line, 10kV line-earth	DM 6kV, CM 10kV
		Features	Waterproof (IP67)	IP67
		Features	Suitable for Independent Use	Deleted
		Description	Application Environment	Updated
		General Specifications- Net Weight	1000g	1100g
		Safety &EMC Compliance	ENEC	Added
		Safety &EMC Compliance	TUV	Added
		Safety &EMC Compliance	CB	Added
		Safety &EMC Compliance	CCC	Added
		Safety &EMC Compliance	PSE	Added
		Safety &EMC Compliance	EN 55015	EN 55015/GB 17743 (1)
		Safety &EMC Compliance	EN 61000-3-2	EN 61000-3-2/GB 17625.1
		Safety &EMC Compliance	EN 61000-4-5	Updated
Mechanical Outline	/	Updated		
RoHS Compliance	/	Updated		
2023-09-13	C	TUV/PSE logo	/	Deleted
		Product Photograph	/	Updated
		Safety &EMC Compliance	/	Updated
		Dimming	/	Updated
		Programming Connection Diagram	/	Updated
2024-10-14	C	Format	/	Updated