

Features

- Ultra High Efficiency (Up to 95%)
- Full Power at Wide Output Current Range (Constant Power)
- Thermal Sensing and Protection for LED Module
- DALI/3 Timer-Modes Dimmable
- Dim-to-Off with Standby Power $\leq 0.5W$
- Always-on Auxiliary Power: 12Vdc, 200mA
- Output Lumen Compensation
- Input Surge Protection: DM 6kV, CM 10kV
- All-Around Protection: OVP, SCP, OTP
- IP67
- SELV Output
- 7 Years Warranty



Description

The EUD-600SxxxBV series is a 600W, constant-current, programmable LED driver that operates from 90-305 Vac input with excellent power factor. Created for many lighting applications including high bay, sports and horticultural, it provides a dim-to-off mode with low standby power. The high efficiency of these drivers and compact metal case enables them to run cooler, significantly improving reliability and extending product life. To ensure trouble-free operation, protection is provided against input surge, output over voltage, short circuit, and over temperature.

Models

Adjustable Output Current Range	Full-Power Current Range (1)	Default Output Current	Input Voltage Range(2)	Output Voltage Range	Max. Output Power	Typical Efficiency (3)	Typical Power Factor		Model Number (5)
							120Vac	220Vac	
0.11–1.40A	1.10–1.40A	1.4 A	90~305Vac/ 127~300Vdc	214 ~ 545Vdc	600 W	94.5%	0.99	0.96	EUD-600S140BV
0.224-2.80A	2.24–2.80A	2.8 A	90~305Vac/ 127~250Vdc	108 ~ 268Vdc	600 W	95.0%	0.99	0.96	EUD-600S280BV
0.336-4.20A	3.36–4.20A	4.2 A	90~305Vac/ 127~250Vdc	72 ~ 178Vdc	600 W	94.5%	0.99	0.96	EUD-600S420BV
0.448-5.60A	4.48–5.60A	5.6 A	90~305Vac/ 127~250Vdc	54 ~ 134Vdc	600 W	94.5%	0.99	0.96	EUD-600S560BV
0.592-7.40A	5.92–7.40A	7.0 A	90~305Vac/ 127~250Vdc	41 ~ 101Vdc	600 W	94.0%	0.99	0.96	EUD-600S740BV ⁽⁴⁾
0.784-9.80A	7.84–9.80A	9.8 A	90~305Vac/ 127~250Vdc	31 ~ 76Vdc	600 W	94.0%	0.99	0.96	EUD-600S980BV ⁽⁴⁾

- Notes:** (1) Output current range with constant power at 600W
 (2) Certified voltage range: 100-240Vac or 127-250Vdc
 (3) Measured at 100% load and 220Vac input (see below "General Specifications" for details).
 (4) SELV Output
 (5) The models are certificated to global-mark.

I-V Operating Area

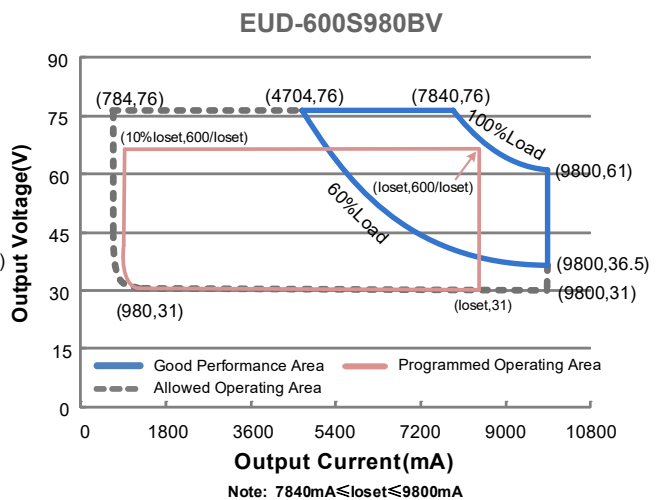
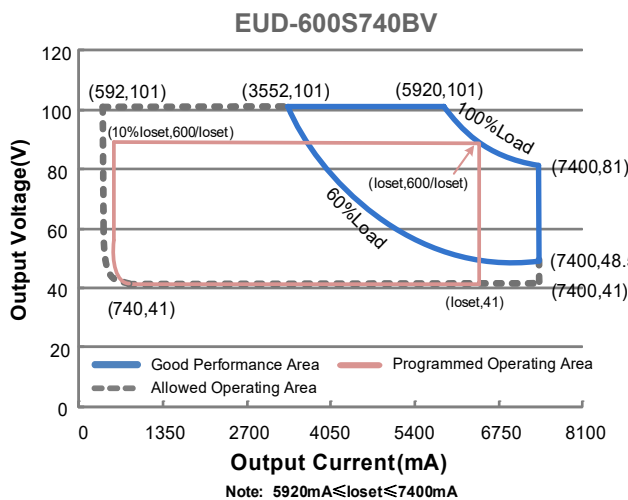
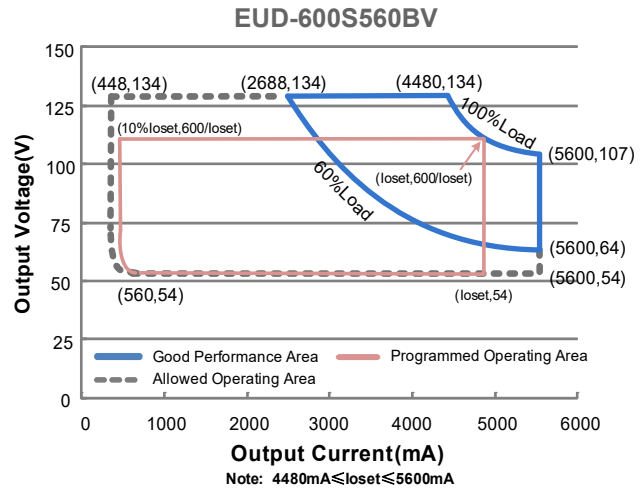
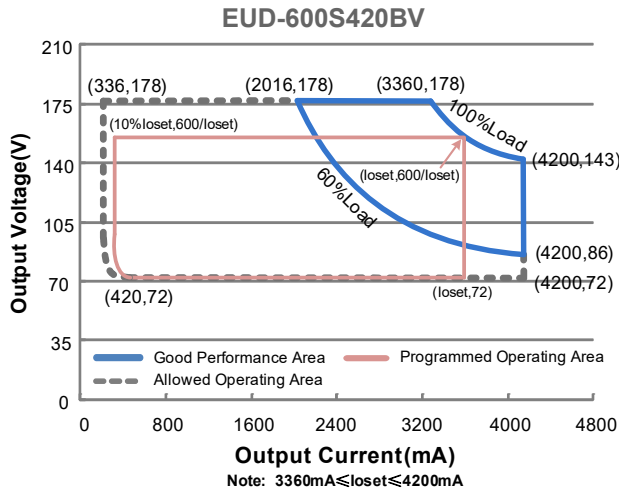
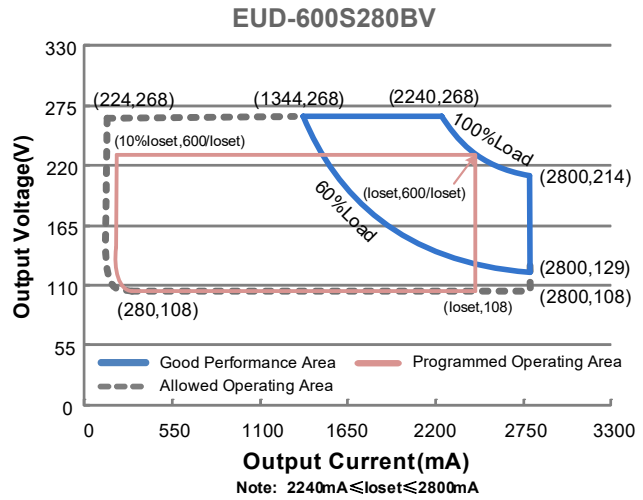
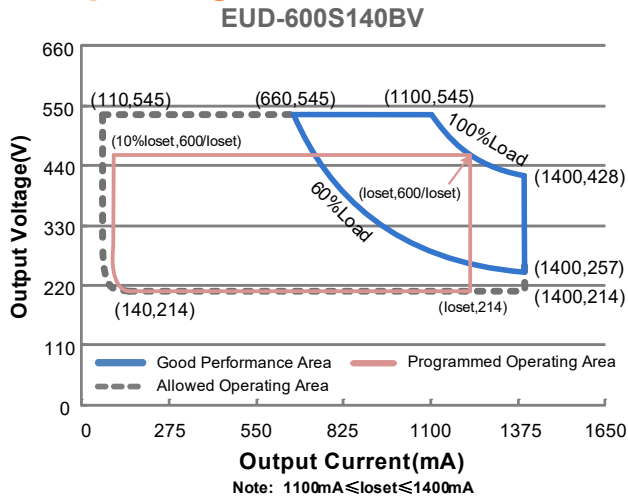

Input Specifications

Parameter	Min.	Typ.	Max.	Notes
Input AC Voltage	90 Vac	-	305 Vac	
Input DC Voltage	127 Vdc	-	250 Vdc	
Input Frequency	47 Hz	-	63 Hz	
Leakage Current	-	-	0.70 mA	IEC60598-1; 240Vac/60Hz, grounding effectively
Input AC Current	-	-	6.0 A	Measured at 100% load and 120 Vac input.
	-	-	3.5 A	Measured at 100% load and 220 Vac input.
Inrush Current(I ² t)	-	-	4.70 A ² s	At 220Vac input, 25°C cold start, duration=7.64 ms, 10%Ipk-10%Ipk. See Inrush Current Waveform for the details.
PF	0.90	-	-	At 100-240Vac, 50-60Hz, 60%-100% Load (360-600W)
THD	-	-	20%	
THD	-	-	10%	At 220-240Vac, 50-60Hz, 75%-100% Load (450-600W)

Output Specifications

Parameter	Min.	Typ.	Max.	Notes
Output Current Tolerance	-5%loset	-	5%loset	At 100% load condition
Output Current Setting(loset) Range				
EUD-600S140BV	110 mA	-	1400 mA	
EUD-600S280BV	224 mA	-	2800 mA	
EUD-600S420BV	336 mA	-	4200 mA	
EUD-600S560BV	448 mA	-	5600 mA	
EUD-600S740BV	592 mA	-	7400 mA	
EUD-600S980BV	784 mA	-	9800 mA	
Output Current Setting Range with Constant Power				
EUD-600S140BV	1100 mA	-	1400 mA	
EUD-600S280BV	2240 mA	-	2800 mA	
EUD-600S420BV	3360 mA	-	4200 mA	
EUD-600S560BV	4480 mA	-	5600 mA	
EUD-600S740BV	5920 mA	-	7400 mA	
EUD-600S980BV	7840 mA	-	9800 mA	
Total Output Current Ripple (pk-pk)	-	5%Iomax	10%Iomax	At 100% load condition, 20 MHz BW
Output Current Ripple at < 200 Hz (pk-pk)	-	2%Iomax	-	At 100% load condition. Only this component of ripple is associated with visible flicker.
Startup Overshoot Current	-	-	10%Iomax	At 100% load condition
No Load Output Voltage				
EUD-600S140BV	-	595 V	600 V	
EUD-600S280BV	-	290 V	295 V	
EUD-600S420BV	-	190 V	200 V	
EUD-600S560BV	-	150 V	155 V	
EUD-600S740BV	-	118 V	120 V	
EUD-600S980BV	-	87 V	95 V	

Output Specifications (Continued)

Parameter	Min.	Typ.	Max.	Notes
Line Regulation	-	-	±0.5%	Measured at 100% load
Load Regulation	-	-	±1.5%	
Turn-on Delay Time	-	-	1.0 s	Measured at 120Vac input, 60%-100% Load.
	-	-	0.5 s	Measured at 220Vac input, 60%-100% Load.
Temperature Coefficient of I _o set	-	0.03%/°C	-	Case temperature = 0°C ~T _c max
12V Auxiliary Output Voltage	10.8 V	12 V	13.2 V	
12V Auxiliary Output Source Current	0 mA	-	200 mA	Return terminal is "OTP-"

General Specifications

Parameter	Min.	Typ.	Max.	Notes
Efficiency at 120 Vac input:				
EUD-600S140BV				
I _o = 1100 mA	90.5%	92.5%	-	
I _o = 1400 mA	90.0%	92.0%	-	
EUD-600S280BV				
I _o = 2240 mA	91.0%	93.0%	-	
I _o = 2800 mA	90.0%	92.0%	-	
EUD-600S420BV				
I _o = 3360 mA	90.5%	92.5%	-	Measured at 100% load and steady-state temperature in 25°C ambient; (Efficiency will be about 2.0% lower if measured immediately after startup.)
I _o = 4200 mA	89.5%	91.5%	-	
EUD-600S560BV				
I _o = 4480 mA	90.0%	92.0%	-	
I _o = 5600 mA	89.5%	91.5%	-	
EUD-600S740BV				
I _o = 5920 mA	89.5%	91.5%	-	
I _o = 7400 mA	89.0%	91.0%	-	
EUD-600S980BV				
I _o = 7840 mA	90.0%	92.0%	-	
I _o = 9800 mA	89.5%	91.5%	-	
Efficiency at 220 Vac input:				
EUD-600S140BV				
I _o = 1100 mA	92.5%	94.5%	-	Measured at 100% load and steady-state temperature in 25°C ambient; (Efficiency will be about 2.0% lower if measured immediately after startup.)
I _o = 1400 mA	92.0%	94.0%	-	
EUD-600S280BV				
I _o = 2240 mA	93.0%	95.0%	-	
I _o = 2800 mA	92.5%	94.5%	-	
EUD-600S420BV				
I _o = 3360 mA	92.5%	94.5%	-	
I _o = 4200 mA	92.0%	94.0%	-	
EUD-600S560BV				
I _o = 4480 mA	92.5%	94.5%	-	
I _o = 5600 mA	92.0%	94.0%	-	
EUD-600S740BV				
I _o = 5920 mA	92.0%	94.0%	-	
I _o = 7400 mA	91.5%	93.5%	-	
EUD-600S980BV				
I _o = 7840 mA	92.0%	94.0%	-	
I _o = 9800 mA	91.0%	93.0%	-	

General Specifications (Continued)

Parameter	Min.	Typ.	Max.	Notes
Efficiency at 277 Vac input: EUD-600S140BV I _o = 1100 mA I _o = 1400 mA EUD-600S280BV I _o = 2240 mA I _o = 2800 mA EUD-600S420BV I _o = 3360 mA I _o = 4200 mA EUD-600S560BV I _o = 4480 mA I _o = 5600 mA EUD-600S740BV I _o = 5920 mA I _o = 7400 mA EUD-600S980BV I _o = 7840 mA I _o = 9800 mA	93.0% 92.5% 93.0% 92.5% 93.0% 92.0% 93.0% 92.5% 92.5% 91.5% 92.5% 91.5%	95.0% 94.5% 95.0% 94.5% 95.0% 94.0% 95.0% 94.5% 94.5% 93.5% 94.5% 93.5%	- - - - - - - - - - - -	Measured at 100% load and steady-state temperature in 25°C ambient; (Efficiency will be about 2.0% lower if measured immediately after startup.)
Standby Power	-	-	0.5 W	Measured at 230Vac/50Hz; Dimming off
MTBF	-	200,000 Hours	-	Measured at 220Vac input, 80%Load and 25°C ambient temperature (MIL-HDBK-217F)
Lifetime	-	108,000 Hours	-	Measured at 220Vac input, 80%Load and 70°C case temperature; See lifetime vs. Tc curve for the details
Operating Case Temperature for Safety Tc _s	-40°C	-	+89°C	
Operating Case Temperature for Warranty Tc _w	-40°C	-	+75°C	Case temperature for 7 years warranty. <i>Please see Inventronics Warranty Statement for complete details.</i>
Storage Temperature	-40°C	-	+85°C	Humidity: 5%RH to 100%RH
Dimensions Inches (L × W × H) Millimeters (L × W × H)	9.84 × 5.67 × 1.91 250 × 144 × 48.5			With mounting ear 10.83 × 5.67 × 1.91 275 × 144 × 48.5
Net Weight	-	3515 g	-	

Dimming Specifications

Parameter	Min.	Typ.	Max.	Notes
DA, DA High Level	9.5V	16V	22.5V	
DA, DA Low Level	-6.5V	0V	6.5V	
DA, DA Current	0mA	-	2mA	

Dimming Specifications (Continued)

Parameter		Min.	Typ.	Max.	Notes
Dimming Output Range	EUD-600S140BV EUD-600S280BV EUD-600S420BV EUD-600S560BV EUD-600S740BV EUD-600S980BV	10%loset	-	loset	1100 mA ≤ loset ≤ 1400 mA 2240 mA ≤ loset ≤ 2800 mA 3360 mA ≤ loset ≤ 4200 mA 4480 mA ≤ loset ≤ 5600 mA 5920 mA ≤ loset ≤ 7400 mA 7840 mA ≤ loset ≤ 9800 mA
	EUD-600S140BV EUD-600S280BV EUD-600S420BV EUD-600S560BV EUD-600S740BV EUD-600S980BV	110 mA 224 mA 336 mA 448 mA 592 mA 784 mA	-	loset	110 mA ≤ loset < 1100 mA 224 mA ≤ loset < 2240 mA 336 mA ≤ loset < 3360 mA 448 mA ≤ loset < 4480 mA 592 mA ≤ loset < 5920 mA 784 mA ≤ loset < 7840 mA

Safety & EMC Compliance

Safety Category	Standard
ENEC & CE	EN 61347-1, EN 61347-2-13
CB	IEC 61347-1, IEC 61347-2-13
global-mark	AS/NZS 61347.1, AS/NZS 61347.2.13
Performance	Standard
ENEC	EN IEC 62384
EMI Standards	Notes
EN IEC 55015 ⁽¹⁾	Conducted emission Test & Radiated emission Test
EN IEC 61000-3-2	Harmonic current emissions
EN 61000-3-3	Voltage fluctuations & flicker
EMS Standards	Notes
EN 61000-4-2	Electrostatic Discharge (ESD): 8 kV air discharge, 4 kV contact discharge
EN 61000-4-3	Radio-Frequency Electromagnetic Field Susceptibility Test-RS
EN 61000-4-4	Electrical Fast Transient / Burst-EFT
EN 61000-4-5	Surge Immunity Test: AC Power Line: Differential Mode 6 kV, Common Mode 10 kV ⁽²⁾
EN 61000-4-6	Conducted Radio Frequency Disturbances Test-CS
EN 61000-4-8	Power Frequency Magnetic Field Test
EN 61000-4-11	Voltage Dips
EN 61547	Electromagnetic Immunity Requirements Applies To Lighting Equipment
DALI Standards	Notes
DALI	IEC 62386-101, 102 & part of 207 ⁽³⁾

Notes: (1) This LED driver meets the EMI specifications above, but EMI performance of a luminaire that contains it depends also on the other devices connected to the driver and on the fixture itself.

- (2) To perform electric strength (hi-pot) testing, the “GDT ground disconnect” (nut and metal lock sheet) on the driver end-cap should be removed temporarily to prevent the internal gas discharge tube from conducting (as allowed by IEC 60598-1 Clause 10.2). After testing is completed, these items must be reinstalled to restore line-to-earth surge protection and secure the end cap.
- (3) Optional Commands Implemented: 242 (query short circuit), 243 (query open circuit).

Derating

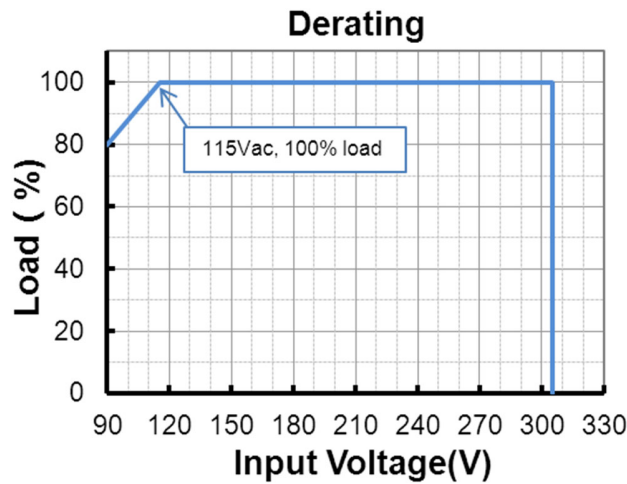

Lifetime vs. Case Temperature

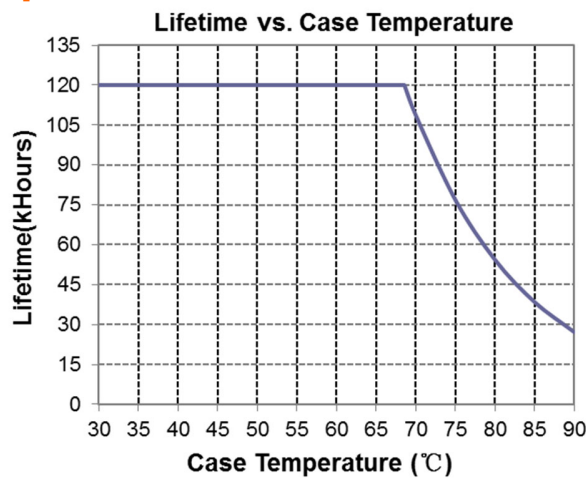

Inrush Current Waveform

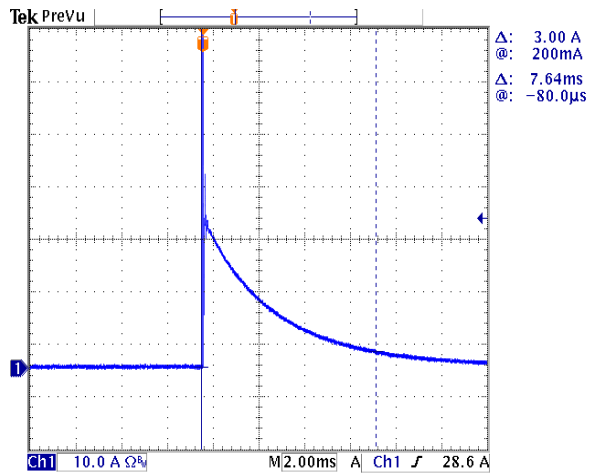

Efficiency vs. Load

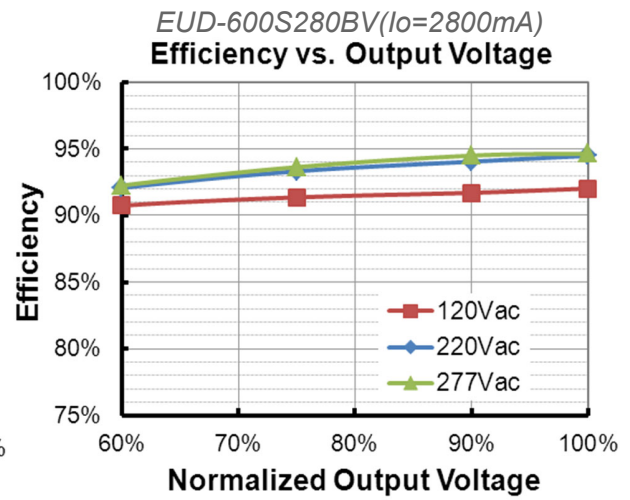
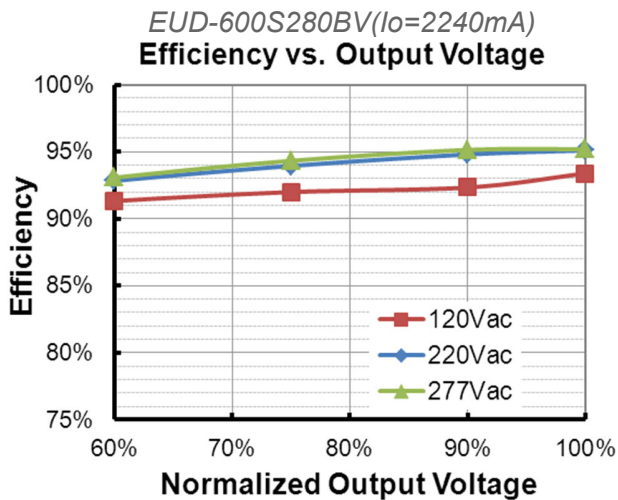
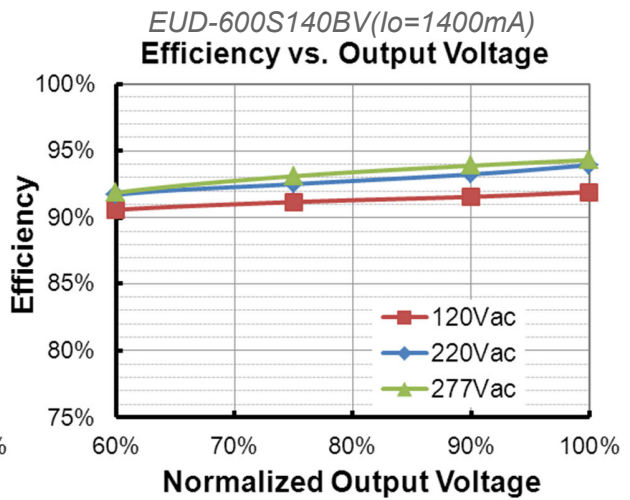
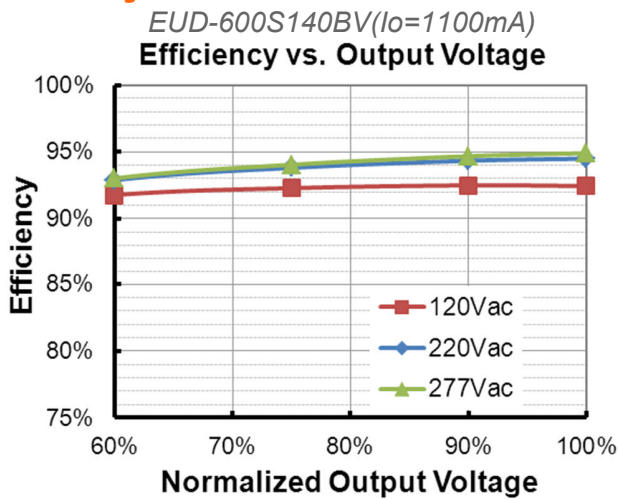

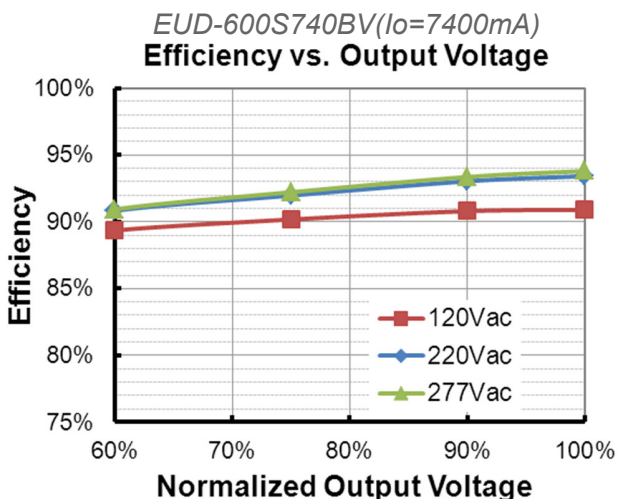
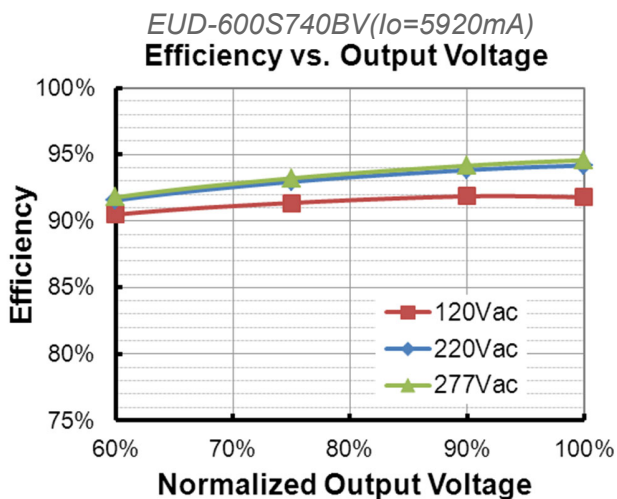
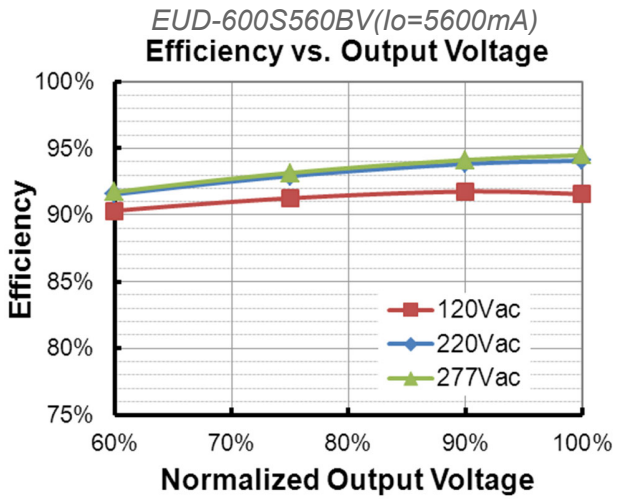
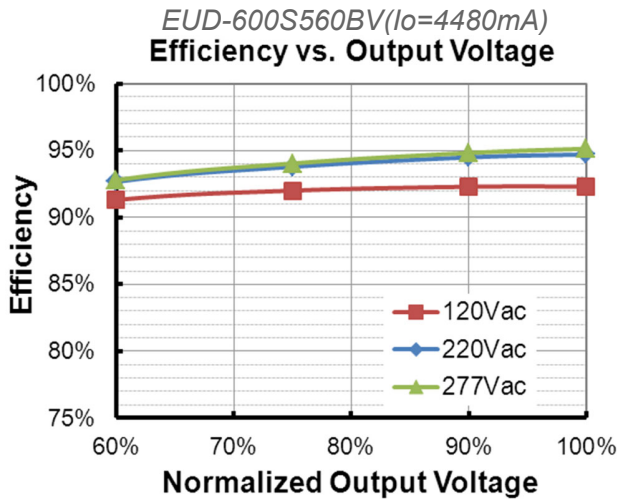
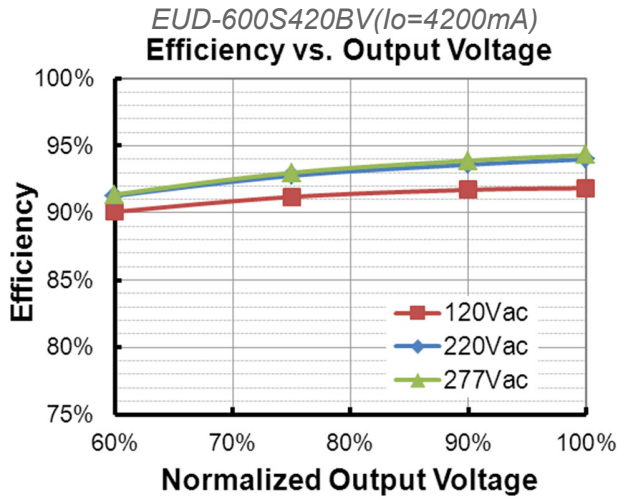
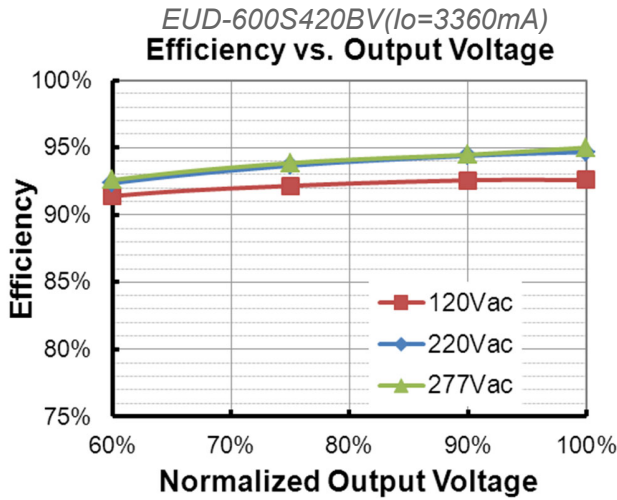

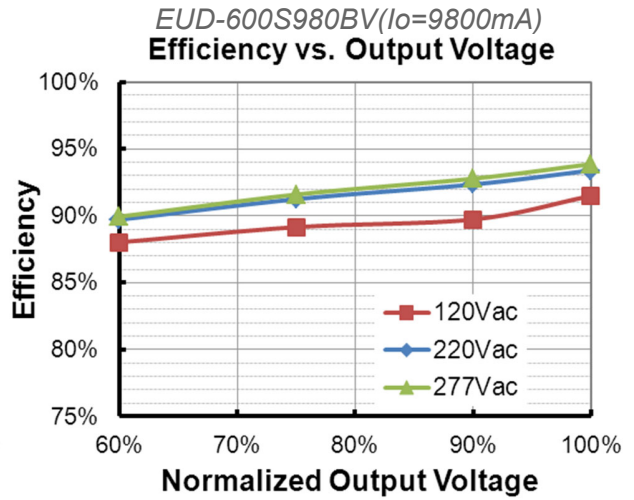
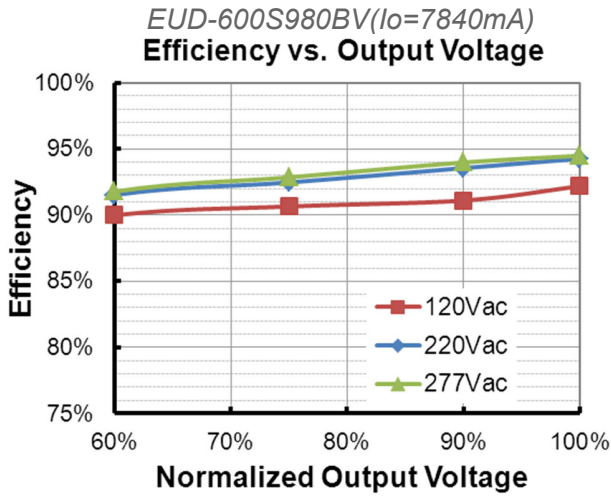

Power Factor

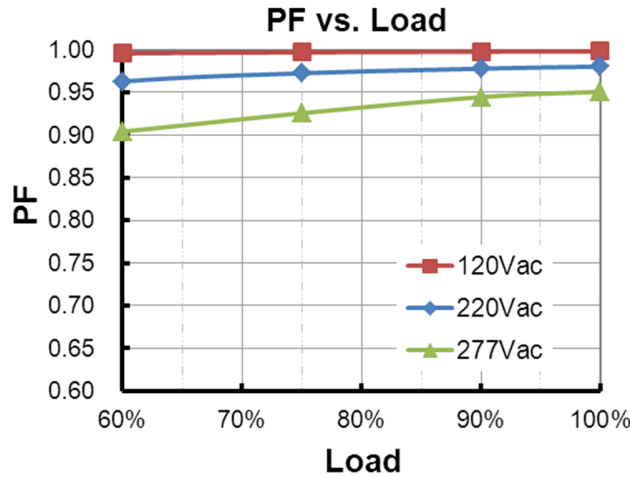

Total Harmonic Distortion

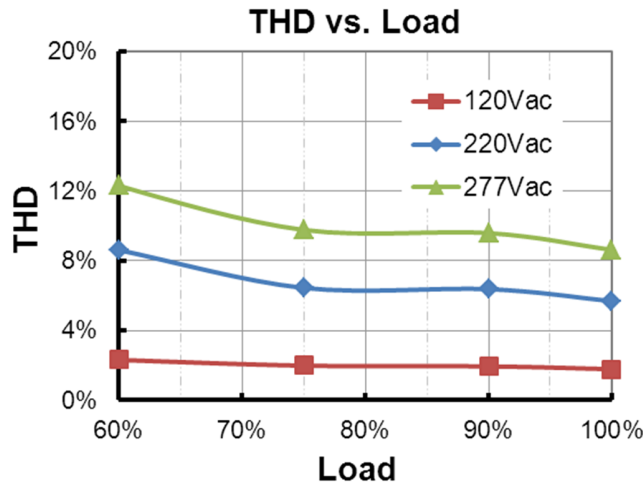

Protection Functions

Parameter		Min.	Typ.	Max.	Notes
External Thermal Protection NTC	R1	-	7.81 kOhm	-	When R_NTC falls below R1, External Thermal Protection is triggered, reducing output current until R2 is reached.
	R2	-	4.16 kOhm	-	When R_NTC is less than R2, output current is reduced to the programmed "Protection Current Floor."
	Protection Current Floor	10%loset	60%loset	100%loset	10%loset > lomin (default setting is 60%)
lomin		60%loset	100%loset	10%loset ≤ lomin (default setting is 60%)	
Over Temperature Protection		Decreases output current, returning to normal after over temperature is removed.			
Short Circuit Protection		Auto Recovery. No damage will occur when any output is short circuited. The output shall return to normal when the fault condition is removed.			
Over Voltage Protection		Limits output voltage at no load and in case the normal voltage limit fails.			

Dimming

● DALI Dimming

The recommended implementation of the dimming control is provided below.

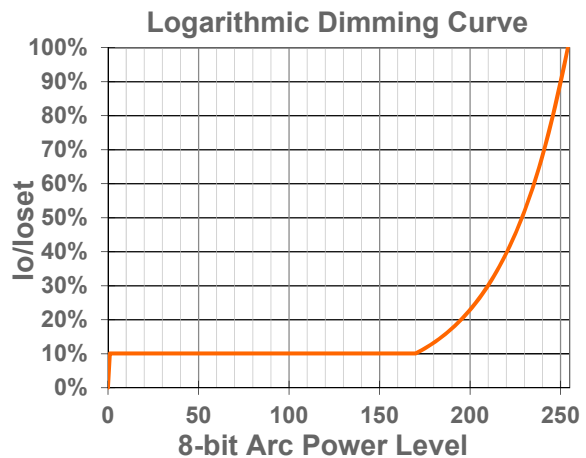
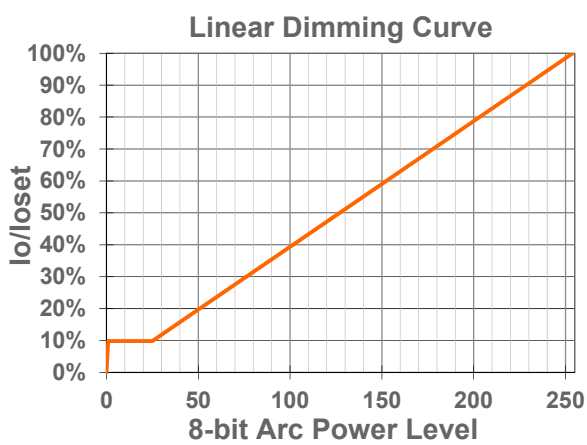
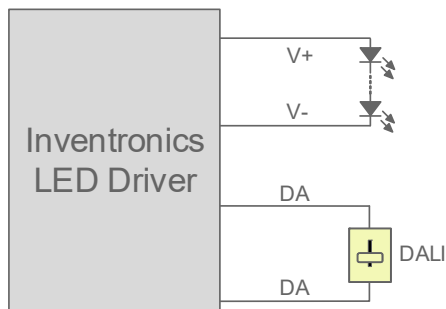

Implementation: DALI Dimming

● Time Dimming

Time dimming control includes 3 kinds of modes, they are Self Adapting-Midnight, Self Adapting-Percentage and Traditional Timer.

- **Self Adapting-Midnight:** Automatically adjusts the dimming curve based on the on-time of past two days (if difference <15 minutes), assuming that the center point of the dimming curve is midnight local time.
- **Self Adapting-Percentage:** Automatically adjusts the on-time of each step by a constant percentage = (actual on-time for the past 2 days if difference <15 min) / (programmed on-time from the dimming curve).
- **Traditional Timer:** Follows the programmed timing curve after power on with no changes.

● Output Lumen Compensation

Output Lumen Compensation (OLC) may be used to maintain constant light output over the life of the LEDs by driving them at a reduced current when new, then gradually increasing the drive current over time to counteract LED lumen degradation.

Programming Connection Diagram

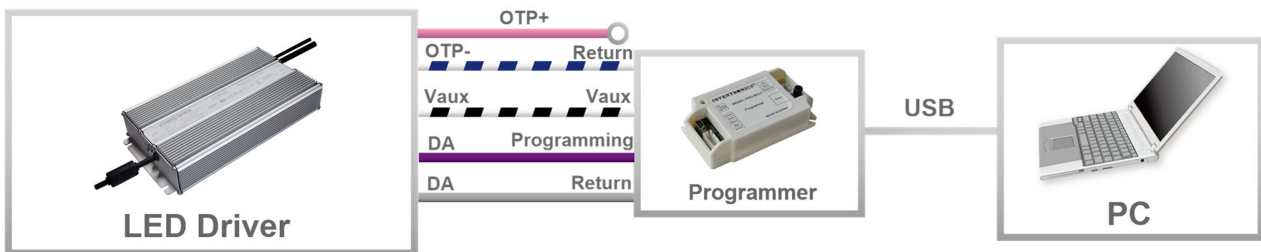

- Note:** (1) The driver does not need to be powered on during the programming process.
 (2) Both "OTP-" and "DA" (gray) should be connected to "Return" of the programmer when programming.

- Please refer to [PRG-MUL2](#) (Programmer) datasheet for details.

Mechanical Outline

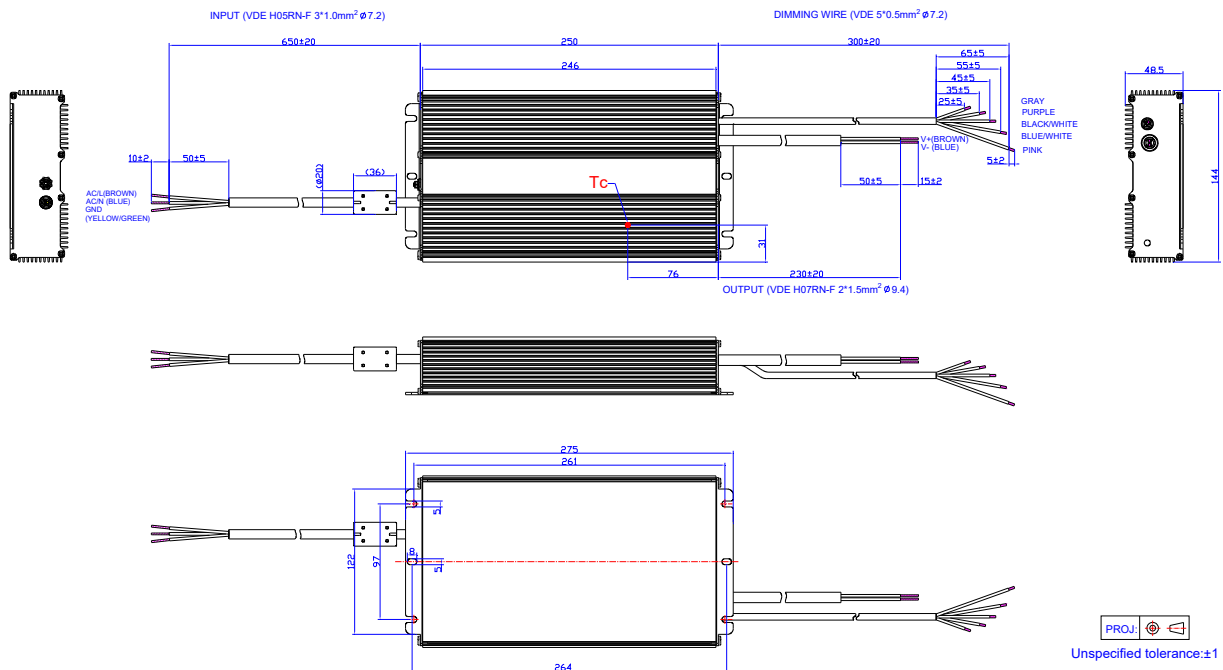

RoHS Compliance

Our products comply with reference to RoHS Directive (EU) 2015/863 amending 2011/65/EU, calling for the elimination of lead and other hazardous substances from electronic products.

Revision History

Change Date	Rev.	Description of Change		
		Item	From	To
2017-05-15	A	Datasheets Release	/	/
2017-10-25	B	Features	7 Years Warranty	Added
		Input Specifications	PF/THD	Updated
		General Specifications	Operating Case Temperature for Warranty T _{c w}	Updated
2018-01-17	C	Output Specifications	No Load Output Voltage	Updated
		General Specifications	Lifetime	Updated
		Operating Case Temperature for Warranty T _{c w}	+70°C	+75°C
		Lifetime vs. Case Temperature	/	Updated
2019-01-18	D	Features	DALI/Timer Dimmable (3 Timer Modes)	DALI/3 Timer-Modes Dimmable
		Models	EUD-600S140BV	Added
		I-V Operating Area	EUD-600S140BV	Added
		Output Specifications - Output Current Setting(losset) Range	EUD-600S140BV	Added
		Output Specifications - Output Current Setting Range with Constant Power	EUD-600S140BV	Added
		Output Specifications - No Load Output Voltage	EUD-600S140BV	Added
		General Specifications - Efficiency at 120 Vac input:	EUD-600S140BV	Added
		General Specifications - Efficiency at 220 Vac input:	EUD-600S140BV	Added
		General Specifications - Efficiency at 277 Vac input:	EUD-600S140BV	Added
		Dimming Specifications - Dimming Output Range	EUD-600S140BV	Added
		Standards Compliance	/	Updated
		Efficiency vs. Load curve	EUD-600S140BV	Added
Total Harmonic Distortion curve	/	Updated		
2024-05-20	E	Product Photograph	/	Updated
		TUV logo	/	Deleted
		global-mark/Independent logo	/	Added
		CCC logo	/	Updated
		Features	/	Updated
		Models	Notes (5)	Added
		Safety &EMC Compliance	/	Updated
		Programming Connection Diagram	/	Updated

Revision History (Continued)

Change Date	Rev.	Description of Change		
		Item	From	To
2024-05-20	E	RoHS Compliance	/	Updated
2024-09-11	F	Format	/	Updated
		CCC logo	/	Deleted
		Models	Notes (2)	Updated
		Safety &EMC Compliance	/	Updated