

## Features

- Ultra High Efficiency (Up to 93.5%)
- Full Power at Wide Output Current Range (Constant Power)
- Adjustable Output Current (AOC) with Dip-switch
- Non-dimming Control
- Input Surge Protection: DM 6kV, CM 10kV
- All-Around Protection: OVP, SCP, OTP
- IP67
- SELV Output
- 5 Years Warranty



## Description

The EUP-200SxxxSV series is a 200W, constant-current, AOC IP67 LED driver that operates from 90-305 Vac input with excellent power factor. It is created for many lighting applications including high bay, high mast, sports and roadway. The high efficiency of these drivers and compact metal case enables them to run cooler, significantly improving reliability and extending product life. To ensure trouble-free operation, protection is provided against input surge, output over voltage, short circuit, and over temperature.

## Models

Adjustable Output Current Range	Full-Power Current Range (1)	Default Output Current	Input Voltage Range(2)	Output Voltage Range	Max. Output Power	Typical Efficiency (3)	Typical Power Factor		Model Number
							120Vac	220Vac	
500-1050mA	700-1050mA	700 mA	90~305 Vac/ 127~250 Vdc	95~286Vdc	200W	93.5%	0.99	0.96	EUP-200S105SV
850-1500mA	1050-1500mA	1050 mA	90~305 Vac/ 127~250 Vdc	67~190Vdc	200W	93.5%	0.99	0.96	EUP-200S150SV
1000-2100mA	1400-2100mA	1400 mA	90~305 Vac/ 127~250 Vdc	48~143Vdc	200W	93.0%	0.99	0.96	EUP-200S210SV
1750-3500mA	2450-3500mA	2800 mA	90~305 Vac/ 127~250 Vdc	29 ~ 82Vdc	200W	93.0%	0.99	0.96	EUP-200S350SV <sup>(4)</sup>
3150-5600mA	3850-5600mA	4900 mA	90~305 Vac/ 127~250 Vdc	18 ~ 52Vdc	200W	92.0%	0.99	0.96	EUP-200S560SV <sup>(4)</sup>

- Notes:** (1) Output current range with constant power at 200W  
 (2) Certified voltage range: 100-240Vac or 127-250Vdc (except CCC)  
 (3) Measured at 100%load and 220Vac input (see below "General Specifications" for details).  
 (4) SELV Output.

## Input Specifications

Parameter	Min.	Typ.	Max.	Notes
Input AC Voltage	90 Vac	-	305 Vac	
Input DC Voltage	127 Vdc	-	250 Vdc	
Input Frequency	47 Hz	-	63 Hz	
Leakage Current	-	-	0.70 mA	IEC 60598-1; 240Vac/60Hz, grounding effectively

## Input Specifications (Continued)

Parameter	Min.	Typ.	Max.	Notes
Input AC Current	-	-	2.15 A	Measured at 100%load and 120 Vac input.
	-	-	1.1 A	Measured at 100%load and 220 Vac input.
Inrush Current(I <sup>2</sup> t)	-	-	1.95 A <sup>2</sup> s	At 220Vac input, 25°C cold start, duration=1.40 ms, 10%I <sub>pk</sub> -10%I <sub>pk</sub> . See Inrush Current Waveform for the details.
PF	0.9	-	-	At 100-240Vac, 50-60Hz, 60%-100% Load (120-200W)
THD	-	-	20%	
THD	-	-	10%	At 220-240Vac, 50-60Hz, 75%-100% Load (150-200W)

## Output Specifications

Parameter	Min.	Typ.	Max.	Notes
Output Current Tolerance	-5%loset	-	5%loset	100%load
Output Current Setting(loset) Range				
EUP-200S105SV	500 mA	-	1050 mA	
EUP-200S150SV	850 mA	-	1500 mA	
EUP-200S210SV	1000 mA	-	2100 mA	
EUP-200S350SV	1750 mA	-	3500 mA	
EUP-200S560SV	3150 mA	-	5600 mA	
Output Current Setting Range with Constant Power				
EUP-200S105SV	700 mA	-	1050 mA	
EUP-200S150SV	1050 mA	-	1500 mA	
EUP-200S210SV	1400 mA	-	2100 mA	
EUP-200S350SV	2450 mA	-	3500 mA	
EUP-200S560SV	3850 mA	-	5600 mA	
Total Output Current Ripple (pk-pk)	-	5%I <sub>omax</sub>	10%I <sub>omax</sub>	100%load. 20 MHz BW
Output Current Ripple at < 200 Hz (pk-pk)	-	2%I <sub>omax</sub>	-	100%load.
Startup Overshoot Current	-	-	10%I <sub>omax</sub>	100%load
No Load Output Voltage				
EUP-200S105SV	-	-	320 V	
EUP-200S150SV	-	-	220 V	
EUP-200S210SV	-	-	160 V	
EUP-200S350SV	-	-	100 V	
EUP-200S560SV	-	-	60 V	
Line Regulation	-	-	±0.5%	100%load
Load Regulation	-	-	±1.5%	
Turn-on Delay Time	-	-	1.0 s	Measured at 120Vac input, 60%-100% Load
	-	-	0.5 s	Measured at 220Vac input, 60%-100% Load
Temperature Coefficient of loset	-	0.03%/°C	-	Case temperature = 0°C ~T <sub>c</sub> max

## General Specifications

Parameter	Min.	Typ.	Max.	Notes
Efficiency at 120 Vac input: EUP-200S105SV				Measured at 100%load and steady-state temperature in 25°C ambient; (Efficiency will be about 2.0% lower if measured immediately after startup.)
Io= 700 mA	88.5%	90.5%	-	
Io=1050 mA	86.0%	88.0%	-	
EUP-200S150SV				
Io=1050 mA	88.0%	90.0%	-	
Io=1500 mA	86.0%	88.0%	-	
EUP-200S210SV				
Io=1400 mA	88.0%	90.0%	-	
Io=2100 mA	85.5%	87.5%	-	
EUP-200S350SV				
Io=2450 mA	87.5%	89.5%	-	
Io=3500 mA	85.0%	87.0%	-	
EUP-200S560SV				
Io=3850 mA	87.0%	89.0%	-	
Io=5600 mA	84.5%	86.5%	-	
Efficiency at 220 Vac input: EUP-200S105SV				Measured at 100%load and steady-state temperature in 25°C ambient; (Efficiency will be about 2.0% lower if measured immediately after startup.)
Io= 700 mA	91.5%	93.5%	-	
Io=1050 mA	90.0%	92.0%	-	
EUP-200S150SV				
Io=1050 mA	91.5%	93.5%	-	
Io=1500 mA	89.5%	91.5%	-	
EUP-200S210SV				
Io=1400 mA	91.0%	93.0%	-	
Io=2100 mA	88.5%	90.5%	-	
EUP-200S350SV				
Io=2450 mA	91.0%	93.0%	-	
Io=3500 mA	88.5%	90.5%	-	
EUP-200S560SV				
Io=3850 mA	90.0%	92.0%	-	
Io=5600 mA	88.0%	90.0%	-	
Efficiency at 277 Vac input: EUP-200S105SV				Measured at 100%load and steady-state temperature in 25°C ambient; (Efficiency will be about 2.0% lower if measured immediately after startup.)
Io= 700 mA	92.0%	94.0%	-	
Io=1050 mA	90.5%	92.5%	-	
EUP-200S150SV				
Io=1050 mA	92.0%	94.0%	-	
Io=1500 mA	90.0%	92.0%	-	
EUP-200S210SV				
Io=1400 mA	91.5%	93.5%	-	
Io=2100 mA	89.0%	91.0%	-	
EUP-200S350SV				
Io=2450 mA	91.5%	93.5%	-	
Io=3500 mA	89.0%	91.0%	-	
EUP-200S560SV				
Io=3850 mA	90.5%	92.5%	-	
Io=5600 mA	88.0%	90.0%	-	
MTBF	-	329,000 Hours	-	Measured at 220Vac input, 80%Load and 25°C ambient temperature (MIL-HDBK-217F)
Lifetime	-	85,000 Hours	-	Measured at 220Vac input, 80%Load and 70°C case temperature; See lifetime vs. Tc curve for the details
Operating Case Temperature for Safety Tc_s	-40°C	-	+90°C	

## General Specifications (Continued)

Parameter	Min.	Typ.	Max.	Notes
Operating Case Temperature for Warranty Tc_w	-40°C	-	+75°C	Case temperature for 5 years warranty Humidity: 10%RH to 95%RH
Storage Temperature	-40°C	-	+85°C	Humidity: 5%RH to 95%RH
Dimensions Inches (L x W x H) Millimeters (L x W x H)	7.96 x 2.66 x 1.56 202 x 67.5 x 39.7			With mounting ear 8.70 x 2.66 x 1.56 221 x 67.5 x 39.7
Net Weight	-	1100 g	-	

## Safety & EMC Compliance

Safety Category	Standard
ENEC & CE	EN 61347-1, EN 61347-2-13
CB	IEC 61347-1, IEC 61347-2-13
CCC	GB 19510.1, GB 19510.14
PSE	J 61347-1, J 61347-2-13
KS	KS C 7655
BIS	IS 15885(Part2/Sec13)
Performance	Standard
ENEC	EN IEC 62384
EMI Standards	Notes
EN IEC 55015/GB/T 17743/ KS C 9815 <sup>(1)</sup>	Conducted emission Test & Radiated emission Test
EN IEC 61000-3-2/GB 17625.1	Harmonic current emissions
EN 61000-3-3	Voltage fluctuations & flicker
EMS Standards	Notes
EN 61000-4-2	Electrostatic Discharge (ESD): 8 kV air discharge, 4 kV contact discharge
EN 61000-4-3	Radio-Frequency Electromagnetic Field Susceptibility Test-RS
EN 61000-4-4	Electrical Fast Transient / Burst-EFT
EN 61000-4-5	Surge Immunity Test: AC Power Line: Differential Mode 6 kV, Common Mode 10 kV <sup>(2)</sup>
EN 61000-4-6	Conducted Radio Frequency Disturbances Test-CS
EN 61000-4-8	Power Frequency Magnetic Field Test
EN 61000-4-11	Voltage Dips
EN 61547/KS C 9547	Electromagnetic Immunity Requirements Applies To Lighting Equipment

**Note:** (1) This LED driver meets the EMI specifications above, but EMI performance of a luminaire that contains it depends also on the other devices connected to the driver and on the fixture itself.

(2) To perform electric strength (hi-pot) testing, the “GDT ground disconnect” (nut and metal lock sheet) on the driver end-cap should be removed temporarily to prevent the internal gas discharge tube from conducting (as allowed by IEC 60598-1 Clause 10.2). After testing is completed, these items must be reinstalled to restore line-to-earth surge protection and secure the end cap.

## Derating

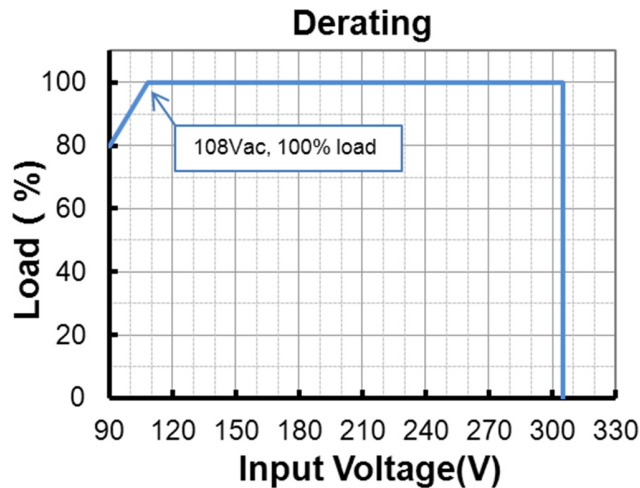

## Lifetime vs. Case Temperature

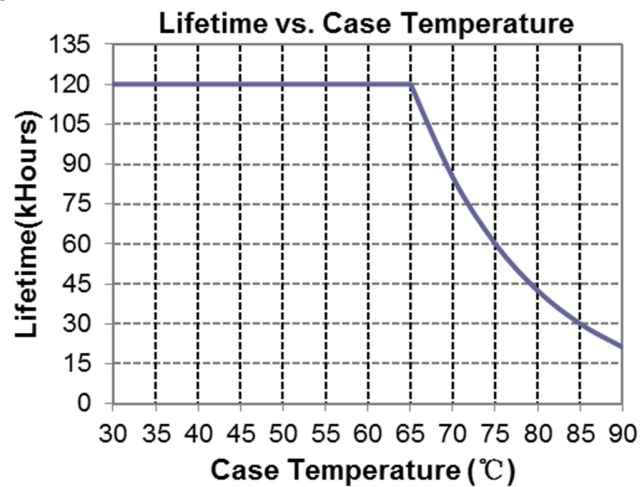

## Inrush Current Waveform

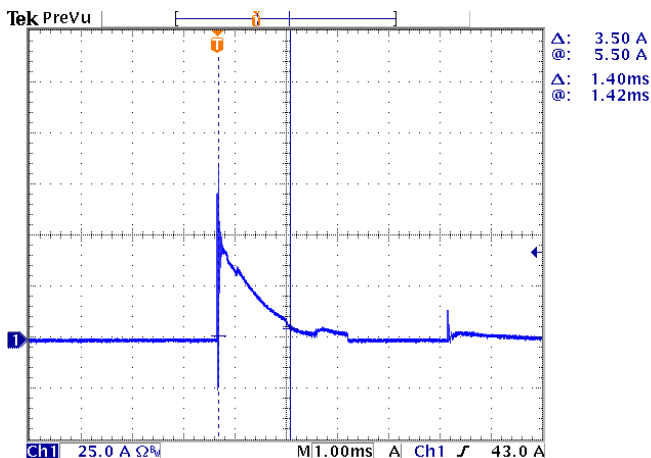

## Efficiency vs. Load

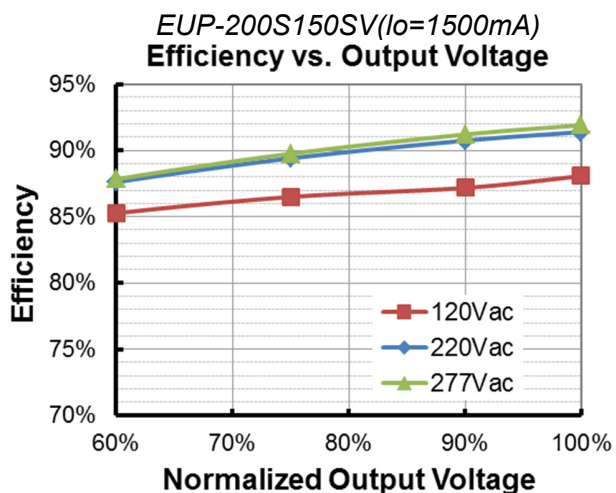
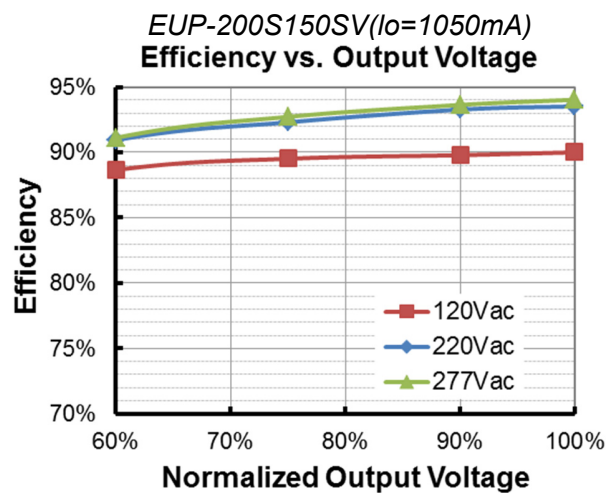
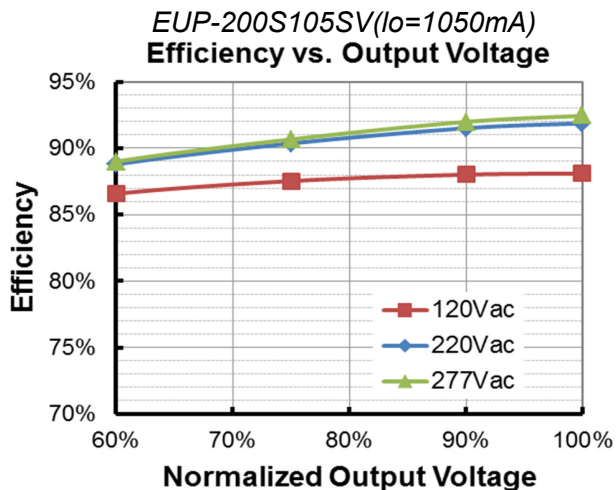
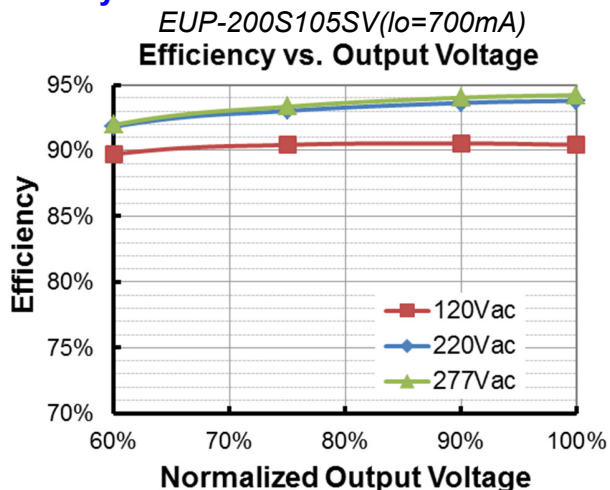

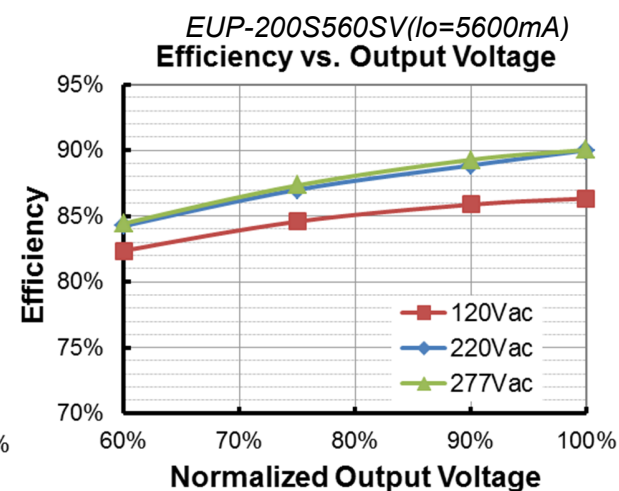
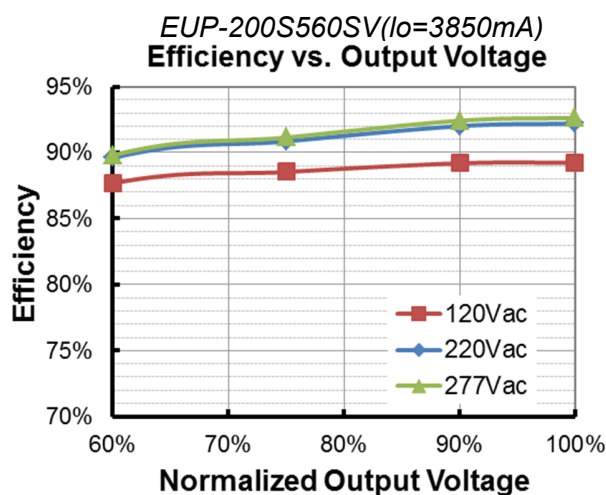
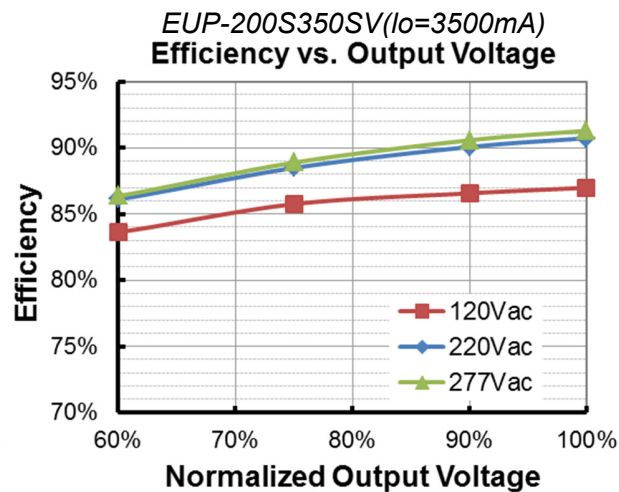
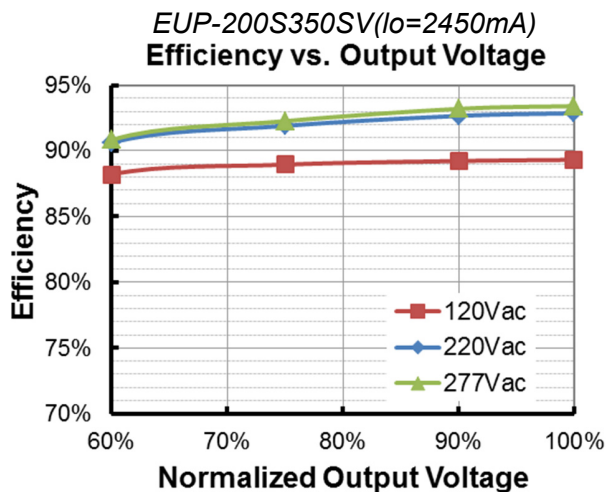
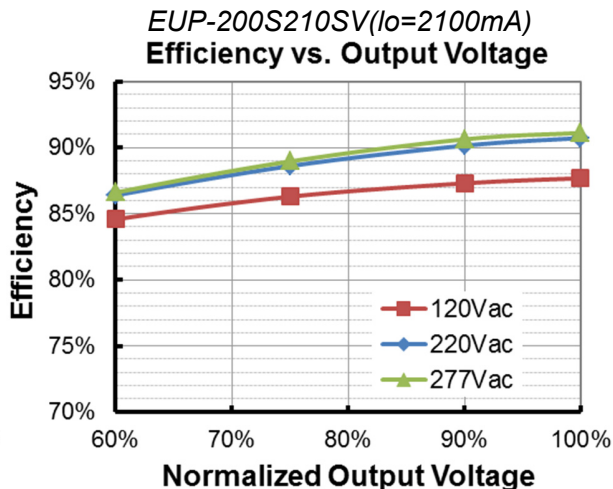
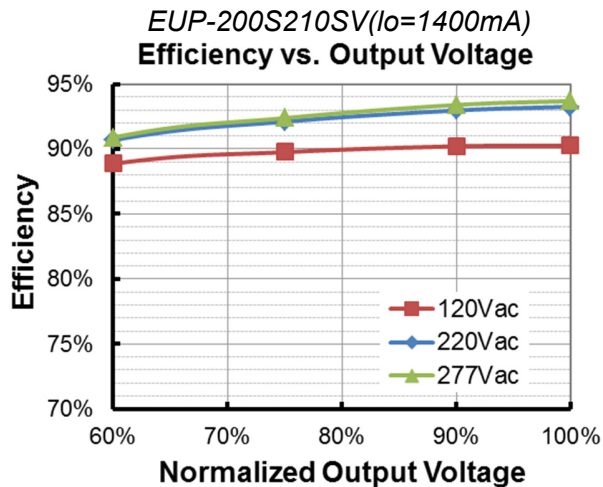

## Power Factor

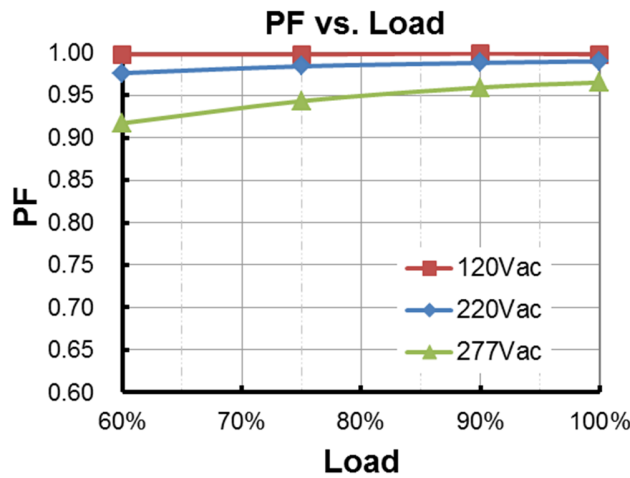

## Total Harmonic Distortion

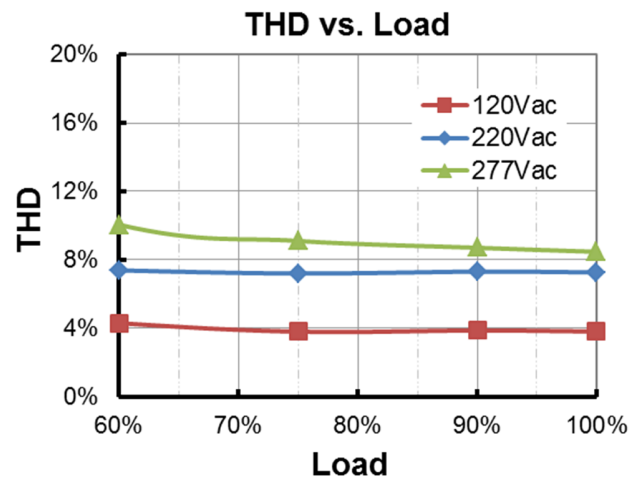

## Protection Functions

Parameter	Notes
Over Temperature Protection	Decreases output current, returning to normal after over temperature is removed.
Short Circuit Protection	Auto Recovery. No damage will occur when any output is short circuited. The output shall return to normal when the fault condition is removed.
Over Voltage Protection	Limits output voltage at no load and in case the normal voltage limit fails.



## Output Current vs. Dip Switch Setting

### ● EUP-200S105SV

Dip Switch Setting				Output Current Setting(loset)	Output Voltage Range		Notes
1	2	3	4	Typ.	Min.	Max.	/
ON	ON	ON	ON	1050mA	95V	190V	Output Current Setting with Constant Power.
ON	ON	ON	OFF	1000mA	100V	200V	
ON	ON	OFF	ON	950mA	105V	210V	
ON	ON	OFF	OFF	900mA	111V	222V	
ON	OFF	ON	ON	850mA	118V	235V	
ON	OFF	ON	OFF	800mA	125V	250V	
ON	OFF	OFF	ON	750mA	133V	266V	
ON	OFF	OFF	OFF	700mA	143V	286V	
OFF	ON	ON	ON	650mA	154V	286V	Output Current Setting with Power Derating.
OFF	ON	ON	OFF	600mA	167V	286V	
OFF	ON	OFF	ON	550mA	182V	286V	
OFF	ON	OFF	OFF	500mA	200V	286V	

● EUP-200S150SV

Dip Switch Setting				Output Current Setting(lose)	Output Voltage Range		Notes
1	2	3	4	Typ.	Min.	Max.	/
ON	ON	ON	ON	1500mA	67V	133V	Output Current Setting with Constant Power.
ON	ON	ON	OFF	1450mA	69V	138V	
ON	ON	OFF	ON	1400mA	72V	143V	
ON	ON	OFF	OFF	1350mA	74V	148V	
ON	OFF	ON	ON	1300mA	77V	154V	
ON	OFF	ON	OFF	1250mA	80V	160V	
ON	OFF	OFF	ON	1200mA	84V	167V	
ON	OFF	OFF	OFF	1150mA	87V	174V	
OFF	ON	ON	ON	1100mA	91V	182V	
OFF	ON	ON	OFF	1050mA	95V	190V	
OFF	ON	OFF	ON	1000mA	100V	190V	Output Current Setting with Power Derating.
OFF	ON	OFF	OFF	950mA	105V	190V	
OFF	OFF	ON	ON	900mA	111V	190V	
OFF	OFF	ON	OFF	850mA	118V	190V	

● EUP-200S210SV

Dip Switch Setting				Output Current Setting(lose)	Output Voltage Range		Notes
1	2	3	4	Typ.	Min.	Max.	/
ON	ON	ON	ON	2100mA	48V	95V	Output Current Setting with Constant Power.
ON	ON	ON	OFF	2000mA	50V	100V	
ON	ON	OFF	ON	1900mA	53V	105V	
ON	ON	OFF	OFF	1800mA	56V	111V	
ON	OFF	ON	ON	1700mA	59V	118V	
ON	OFF	ON	OFF	1600mA	63V	125V	
ON	OFF	OFF	ON	1500mA	67V	133V	
ON	OFF	OFF	OFF	1400mA	72V	143V	
OFF	ON	ON	ON	1300mA	77V	143V	
OFF	ON	ON	OFF	1200mA	84V	143V	
OFF	ON	OFF	ON	1100mA	91V	143V	
OFF	ON	OFF	OFF	1000mA	100V	143V	

● EUP-200S350SV

Dip Switch Setting				Output Current Setting(lose)	Output Voltage Range		Notes
1	2	3	4	Typ.	Min.	Max.	/
ON	ON	ON	ON	3500mA	29V	57V	Output Current Setting with Constant Power.
ON	ON	ON	OFF	3325mA	30V	60V	
ON	ON	OFF	ON	3150mA	32V	63.5V	
ON	ON	OFF	OFF	2975mA	34V	67V	
ON	OFF	ON	ON	2800mA	36V	71.5V	
ON	OFF	ON	OFF	2625mA	38V	76V	
ON	OFF	OFF	ON	2450mA	41V	82V	
ON	OFF	OFF	OFF	2275mA	44V	82V	
OFF	ON	ON	ON	2100mA	48V	82V	
OFF	ON	ON	OFF	1925mA	52V	82V	
OFF	ON	OFF	ON	1750mA	57V	82V	

● EUP-200S560SV

Dip Switch Setting				Output Current Setting(lose)	Output Voltage Range		Notes
1	2	3	4	Typ.	Min.	Max.	/
OFF	ON	ON	ON	5600mA	18V	35.5V	Output Current Setting with Constant Power.
OFF	ON	ON	OFF	5250mA	19V	38V	
OFF	ON	OFF	ON	4900mA	21V	41V	
OFF	ON	OFF	OFF	4550mA	22V	44V	
OFF	OFF	ON	ON	4200mA	24V	47.5V	
OFF	OFF	ON	OFF	3850mA	26V	52V	
OFF	OFF	OFF	ON	3500mA	28V	52V	Output Current Setting with Power Derating.
OFF	OFF	OFF	OFF	3150mA	31V	52V	

Notes:

1. Dip switch must be set in the setting range as specified to insure the driver operates as expected.
2. Endcap covering dip switch must be tight to insure IP67 rating.

## Mechanical Outline

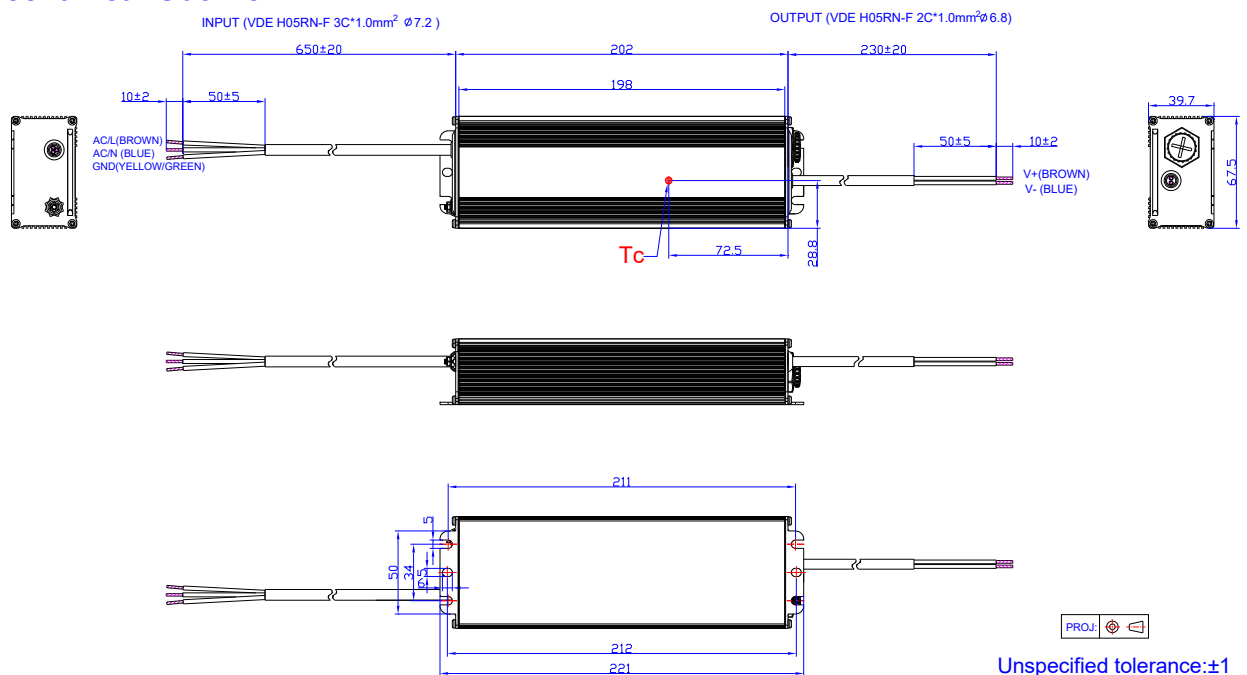

## RoHS Compliance

Our products comply with reference to RoHS Directive (EU) 2015/863 amending 2011/65/EU, calling for the elimination of lead and other hazardous substances from electronic products.

## Revision History

Change Date	Rev.	Description of Change		
		Item	From	To
2017-10-19	A	Datasheets Release	/	/
2018-04-25	B	Description	/	Updated
		Mechanical Outline	/	Updated
2018-07-16	C	EAC	/	Added
2023-08-04	D	Product Photograph	/	Updated
		TUV logo	/	Deleted
		Independent logo	/	Added
		Features	/	Updated
		General Specifications	Humidity	Updated
		Safety &EMC Compliance	/	Updated
2024-05-16	E	RoHS Compliance	/	Updated
		Product Photograph	/	Updated
		EAC logo	/	Deleted
		KCC logo	/	Added
		Safety &EMC Compliance	/	Updated