

Features

- Ultra High Efficiency (Up to 96%)
- Full Power at Wide Output Current Range (Constant Power)
- Adjustable Output Current (AOC)with NFC
- DALI-2 and D4i Certified
- 3-Timer-Modes Dimmable
- Dim-to-Off with Standby Power $\leq 0.5W$
- Dimming range: 5%-100%
- Always-on Auxiliary Power: 24Vdc,125mA,3W (Transient Peak Power up to 10W)
- Integrated 16Vdc Bus Power Supply based on DALI-2
- Integrated Power Monitoring with High Accuracy up to $\pm 1\%$
- Low inrush current
- Output Lumen Compensation
- End-of-Life Indicator
- Thermal Sensing and Protection for LED Module
- Input Surge Protection: DM 6kV, CM 10kV
- All-Around Protection: IUVP, IOVP, OVP, SCP, OTP
- IP66/IP67 and UL Dry/Damp/Wet Location
- TYPE HL, for use in a Class I, Division 2 Hazardous (Classified) Location
- 7 Years Warranty



Description

The EUM-680SxxxBG series is a 680W, constant-current, NFC programmable and IP66/IP67 rated LED driver that operates from 90-305Vac input with excellent power factor. Created for intra-luminaire solutions and health monitoring applications, this family provides integrated AC power monitoring with an auxiliary voltage and dim-to-off functionality for powering low voltage, wireless controls. The dimming control supports two-way communication via DALI-2 and complies with D4i. The high efficiency of these drivers and compact metal case enables them to run cooler, significantly improving reliability and extending product life. To ensure trouble-free operation, protection is provided against input surge, input under voltage, input over voltage, output over voltage, short circuit, and over temperature.

Models

Adjustable Output Current Range(A)	Full-Power Current Range (A) ⁽¹⁾	Default Output Current (A)	Output Voltage Range (Vdc)	Max. Output Power (W)	Typical Efficiency ⁽²⁾	Typical Power Factor		Model Number
						120Vac	220Vac	
0.125-1.7	1.25-1.7	1.7	200-544	680	95.5%	0.99	0.96	EUM-680S170BG
0.18-2.4	1.8-2.4	2.1	141.5-378	680	94.5%	0.99	0.96	EUM-680S240BG
0.26-3.5	2.6-3.5	3.5	97.1-262	680	95.0%	0.99	0.96	EUM-680S350BG
0.42-5.6	4.2-5.6	5.6	60.7-163	680	94.5%	0.99	0.96	EUM-680S560BG
0.63-8.4	6.3-8.4	8.4	40.4-108	680	95.0%	0.99	0.96	EUM-680S840BG ⁽⁴⁾
1.26-15.0	12.6-15.0	15.0	22.6-54	680	95.5%	0.99	0.96	EUM-680S15ABG ⁽⁴⁾

- Notes:** (1) Output current range with constant power at 680W.
 (2) Measured at 100% load and 220Vac input (see below "General Specifications" for details).
 (3) Certified input voltage range: UL, FCC 100-277Vac; otherwise 100-240Vac
 (4) SELV output.

I-V Operating Area

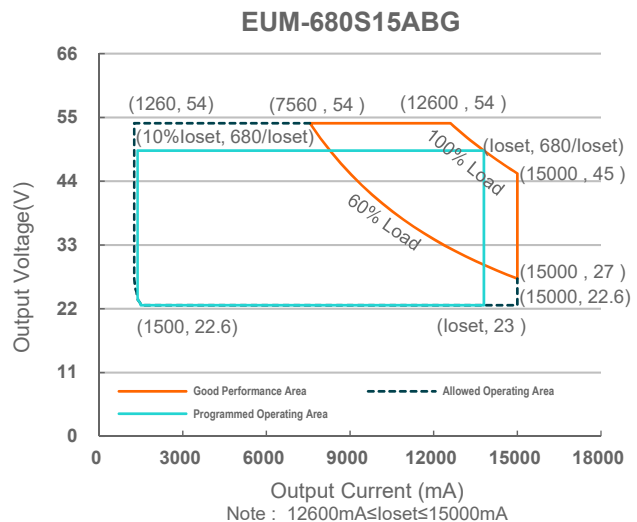
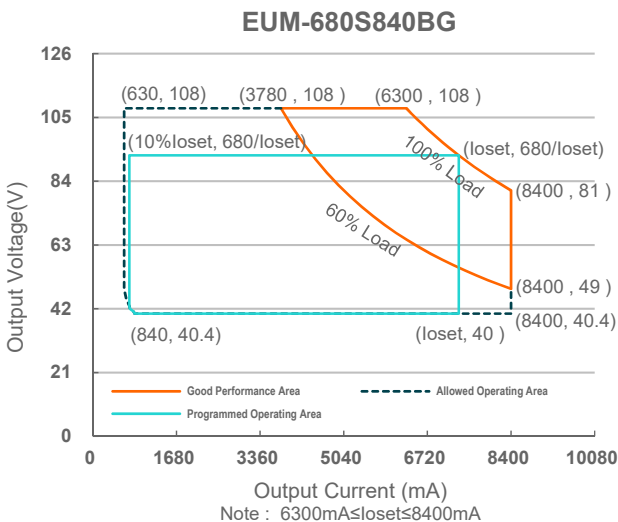
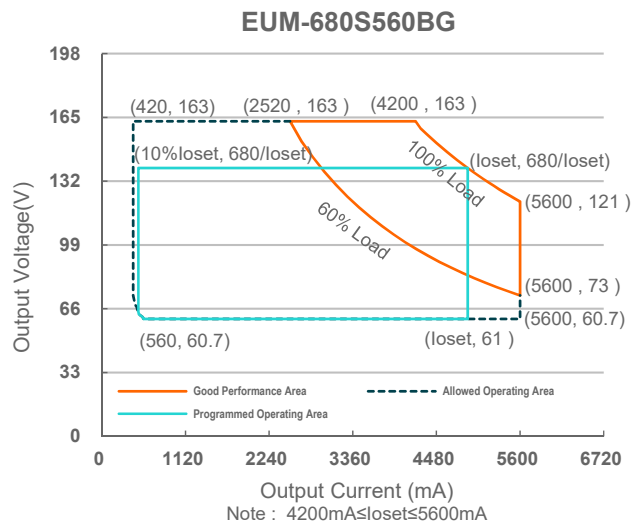
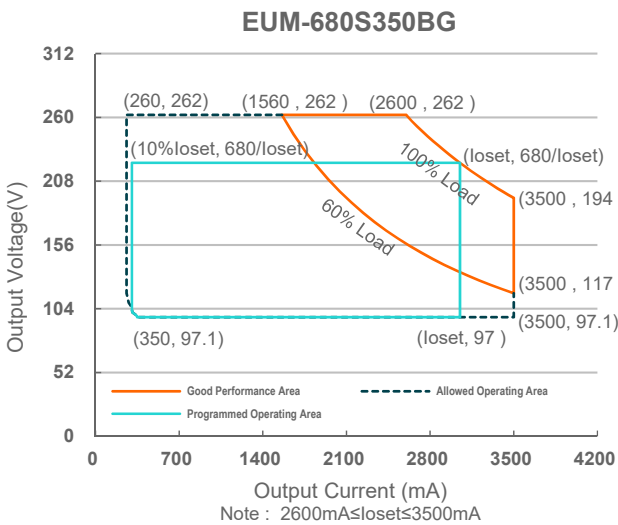
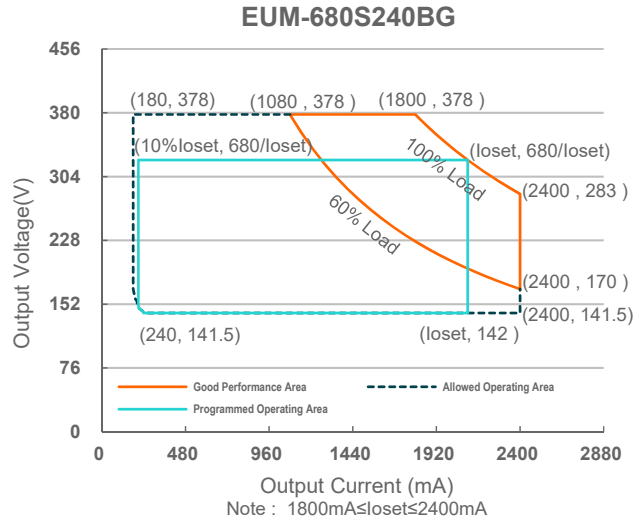
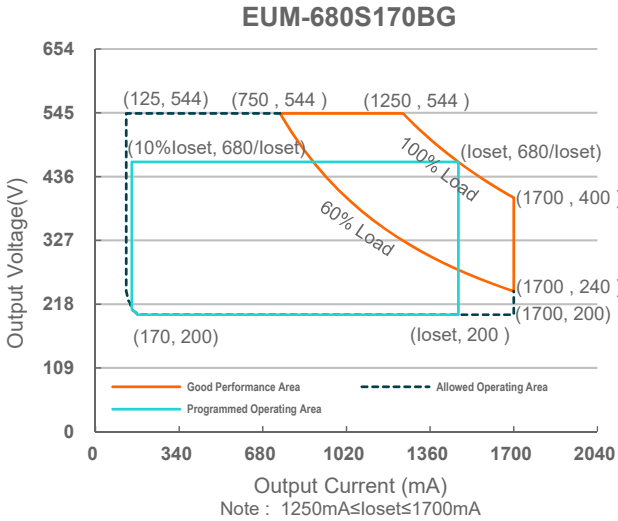

Input Specifications

Parameter	Min.	Typ.	Max.	Notes
Input AC Voltage	90 Vac	-	305 Vac	
Input DC Voltage	127 Vdc	-	300 Vdc	
Input Frequency	47 Hz	-	63 Hz	
Leakage Current	-	-	0.75 MIU	UL 8750; 277Vac/60Hz
	-	-	0.70 mA	IEC 60598-1; 240Vac/60Hz
Input AC Current	-	-	6.9 A	Measured at 100% load and 120 Vac input.
	-	-	3.6 A	Measured at 100% load and 220 Vac input.
Inrush Current(I ² t)	-	-	2.1 A ² s	At 220Vac input, 25°C cold start, duration=14.2 ms, 10%I _{pk} -10%I _{pk} .
PF	0.9	-	-	At 100-277Vac, 50-60Hz, 60%-100% Load (408 - 680W)
THD	-	-	20%	
THD	-	-	10%	At 220-240Vac, 50-60Hz, 75%-100% Load (510 - 680W)

Output Specifications

Parameter	Min.	Typ.	Max.	Notes
Output Current Tolerance	-5%loset	-	5%loset	100% load
Output Current Setting (loset) Range				
EUM-680S170BG	125 mA	-	1700 mA	
EUM-680S240BG	180 mA	-	2400 mA	
EUM-680S350BG	260 mA	-	3500 mA	
EUM-680S560BG	420 mA	-	5600 mA	
EUM-680S840BG	630 mA	-	8400 mA	
EUM-680S15ABG	1260 mA	-	15000 mA	
Output Current Setting Range with Constant Power				
EUM-680S170BG	1250 mA	-	1700 mA	
EUM-680S240BG	1800 mA	-	2400 mA	
EUM-680S350BG	2600 mA	-	3500 mA	
EUM-680S560BG	4200 mA	-	5600 mA	
EUM-680S840BG	6300 mA	-	8400 mA	
EUM-680S15ABG	12600 mA	-	15000 mA	
Total Output Current Ripple (pk-pk)	-	5%I _{omax}	10%I _{omax}	100% load, 20 MHz BW
Output Current Ripple at < 200 Hz (pk-pk)	-	-	2%I _{omax}	70%-100% load
Startup Overshoot Current	-	-	10%I _{omax}	100% load
No Load Output Voltage				
EUM-680S170BG	-	-	600 V	
EUM-680S240BG	-	-	420 V	
EUM-680S350BG	-	-	300 V	
EUM-680S560BG	-	-	200 V	
EUM-680S840BG	-	-	120 V	
EUM-680S15ABG	-	-	60 V	
Line Regulation	-	-	±0.5%	100% load

Output Specifications (Continued)

Parameter	Min.	Typ.	Max.	Notes
Load Regulation	-	-	±3.0%	
Turn-on Delay Time	-	-	0.5 s	Measured at all dimming modes except DALI-2, and 120-277Vac input, 60%-100% Load
	-	-	1.0 s	Measured at DALI-2 dimming mode, and 120-277Vac input, 60%-100% Load
Temperature Coefficient of I _o set	-	0.03%/°C	-	Case temperature = 0°C ~T _c max
24V Auxiliary Output Voltage	21.6 V	24 V	26.4 V	
24V Auxiliary Output Source Current	0 mA	-	125 mA	Return terminal is "DA-"
24V Auxiliary Output Transient Peak Current@6W	-	-	250 mA	250mA peak for a maximum duration of 2.2ms in a 6.0ms period during which time the average should not exceed 125mA.
24V Auxiliary Output Transient Peak Current@10W	-	-	425 mA	425mA peak for a maximum duration of 1.3ms in a 5.2ms period during which time the average should not exceed 125mA.
Integrated DALI-2 Bus Power Supply Voltage	12 Vdc	16 Vdc	20 Vdc	Voltage is depending on loading.
Integrated DALI-2 Bus Power Maximum Supply Current	60 mA			
Integrated DALI-2 Bus Power Guaranteed Supply Current	50 mA			DALI-2 Bus Power Supply Voltage ≥12V

Notes: (1) DALI-2 bus power supply is enabled by default and can be disabled via programming interface.
 (2) DALI-2 bus power supply supports automatic shut-down and restart after short-circuit.

General Specifications

Parameter	Min.	Typ.	Max.	Notes
Efficiency at 120 Vac input:				
EUM-680S170BG				Measured at 100% load and steady-state temperature in 25°C ambient; (Efficiency will be about 2.0% lower if measured immediately after startup.)
I _o = 1250 mA	92.0%	94.0%	-	
I _o = 1700 mA	92.0%	94.0%	-	
EUM-680S240BG				
I _o = 1800 mA	90.5%	92.5%	-	
I _o = 2400 mA	90.0%	92.0%	-	
EUM-680S350BG				
I _o = 2600 mA	90.0%	92.0%	-	
I _o = 3500 mA	90.5%	92.5%	-	
EUM-680S560BG				
I _o = 4200 mA	90.0%	92.0%	-	
I _o = 5600 mA	90.0%	92.0%	-	
EUM-680S840BG				
I _o = 6300 mA	90.5%	92.5%	-	
I _o = 8400 mA	90.5%	92.5%	-	
EUM-680S15ABG				
I _o = 12600 mA	92.0%	94.0%	-	
I _o = 15000 mA	92.0%	94.0%	-	

General Specifications (Continued)

Parameter	Min.	Typ.	Max.	Notes
Efficiency at 220 Vac input: EUM-680S170BG				Measured at 100% load and steady-state temperature in 25°C ambient; (Efficiency will be about 2.0% lower if measured immediately after startup.)
Io= 1250 mA	93.5%	95.5%	-	
Io= 1700 mA	93.5%	95.5%	-	
EUM-680S240BG				
Io= 1800 mA	92.5%	94.5%	-	
Io= 2400 mA	92.5%	94.5%	-	
EUM-680S350BG				
Io= 2600 mA	92.5%	94.5%	-	
Io= 3500 mA	93.0%	95.0%	-	
EUM-680S560BG				
Io= 4200 mA	92.5%	94.5%	-	
Io= 5600 mA	92.5%	94.5%	-	
EUM-680S840BG				
Io= 6300 mA	93.0%	95.0%	-	
Io= 8400 mA	93.0%	95.0%	-	
EUM-680S15ABG				
Io= 12600 mA	93.5%	95.5%	-	
Io= 15000 mA	93.5%	95.5%	-	
Efficiency at 277 Vac input: EUM-680S170BG				Measured at 100% load and steady-state temperature in 25°C ambient; (Efficiency will be about 2.0% lower if measured immediately after startup.)
Io= 1250 mA	93.5%	95.5%	-	
Io= 1700 mA	93.5%	95.5%	-	
EUM-680S240BG				
Io= 1800 mA	93.0%	95.0%	-	
Io= 2400 mA	93.0%	95.0%	-	
EUM-680S350BG				
Io= 2600 mA	93.0%	95.0%	-	
Io= 3500 mA	93.5%	95.5%	-	
EUM-680S560BG				
Io= 4200 mA	93.0%	95.0%	-	
Io= 5600 mA	93.0%	95.0%	-	
EUM-680S840BG				
Io= 6300 mA	93.0%	95.0%	-	
Io= 8400 mA	93.0%	95.0%	-	
EUM-680S15ABG				
Io= 12600 mA	94.0%	96.0%	-	
Io= 15000 mA	94.0%	96.0%	-	
Power Monitoring Accuracy	-1%	-	1%	Measured at 220Vac input and 100%Load
Standby Power	-	-	0.5 W	Measured at 230Vac/50Hz; Dimming off
MTBF	-	201,000 Hours	-	Measured at 220Vac input, 80%Load and 25°C ambient temperature (MIL-HDBK-217F)
Lifetime	-	107,000 Hours	-	Measured at 220Vac input, 80%Load and 70°C case temperature; See lifetime vs. Tc curve for the details
	-	67,000 Hours	-	Measured at 220Vac input, 100%Load and 40°C ambient temperature
Operating Case Temperature for Safety Tc_s	-40°C	-	+90°C	
Operating Case Temperature for Warranty Tc_w	-40°C	-	+75°C	Case temperature for 7 years warranty Humidity: 10%RH to 95%RH
Storage Temperature	-40°C	-	+85°C	Humidity: 5%RH to 95%RH
Dimensions				With mounting ear
Inches (L × W × H)	9.84 × 5.31 × 1.81			10.83 × 5.31 × 1.81
Millimeters (L × W × H)	250 × 135 × 46			275 × 135 × 46
Net Weight	-	3079 g	-	

Dimming Specifications

Parameter		Min.	Typ.	Max.	Notes
DA+, DA- High Level		9.5 V	16 V	22.5 V	
DA+, DA- Low Level		-6.5 V	0 V	6.5 V	
DA+, DA- Current		0 mA	-	2 mA	
Dimming Output Range with 5%-100%	EUM-680S170BG EUM-680S240BG EUM-680S350BG EUM-680S560BG EUM-680S840BG EUM-680S15ABG	5%loset	-	loset	1250 mA ≤ loiset ≤ 1700 mA 1800 mA ≤ loiset ≤ 2400 mA 2600 mA ≤ loiset ≤ 3500 mA 4200 mA ≤ loiset ≤ 5600 mA 6300 mA ≤ loiset ≤ 8400 mA 12600 mA ≤ loiset ≤ 15000 mA
	EUM-680S170BG EUM-680S240BG EUM-680S350BG EUM-680S560BG EUM-680S840BG EUM-680S15ABG	63 mA 90 mA 130 mA 210 mA 315 mA 630 mA	-	loiset	125 mA ≤ loiset < 1250 mA 180 mA ≤ loiset < 1800 mA 260 mA ≤ loiset < 2600 mA 420 mA ≤ loiset < 4200 mA 630 mA ≤ loiset < 6300 mA 1260 mA ≤ loiset < 12600 mA

Safety & EMC Compliance

Safety Category	Standard
UL/CUL	UL 8750, CAN/CSA-C22.2 No. 250.13
ENEC	EN 61347-1, EN 61347-2-13
CE	EN 61347-1, EN 61347-2-13 EN 301 489-1 EN 301 489-3 EN 300 330 EN 62479/EN 50663/EN 50665/EN 50364
CB	IEC 61347-1, IEC 61347-2-13
CCC	GB 19510.1, GB 19510.14
KC	K 61347-1, K 61347-2-13
PSE	J 61347-1, J 61347-2-13
EAC	TP TC 004, TP TC 020
Performance	Standard
ENEC	EN IEC 62384
EMI Standards	Notes
EN IEC 55015/GB/T 17743 ⁽¹⁾	Conducted emission Test & Radiated emission Test
EN IEC 61000-3-2/GB 17625.1	Harmonic current emissions
EN 61000-3-3	Voltage fluctuations & flicker

Safety & EMC Compliance (Continued)

EMI Standards	Notes
FCC Part 15 ⁽¹⁾	ANSI C63.4 Class B This device complies with Part 15 of the FCC Rules. Operation is subject to the following two conditions: [1] this device may not cause harmful interference, and [2] this device must accept any interference received, including interference that may cause undesired Operation.
EMS Standards	Notes
EN 61000-4-2	Electrostatic Discharge (ESD): 8 kV air discharge, 4 kV contact discharge
EN 61000-4-3	Radio-Frequency Electromagnetic Field Susceptibility Test-RS
EN 61000-4-4	Electrical Fast Transient / Burst-EFT
EN 61000-4-5	Surge Immunity Test: AC Power Line: Differential Mode 6 kV, Common Mode 10 kV
EN 61000-4-6	Conducted Radio Frequency Disturbances Test-CS
EN 61000-4-8	Power Frequency Magnetic Field Test
EN 61000-4-11	Voltage Dips
EN 61547	Electromagnetic Immunity Requirements Applies To Lighting Equipment
DALI-2 Standards	Notes
DALI-2 ⁽²⁾	IEC 62386-101, -102 & -207

Notes: (1) This LED driver meets the EMI specifications above, but EMI performance of a luminaire that contains it depends also on the other devices connected to the driver and on the fixture itself.

(2) DALI parts: 101, 102, 150, 207, 250, 251, 252, 253.

Derating

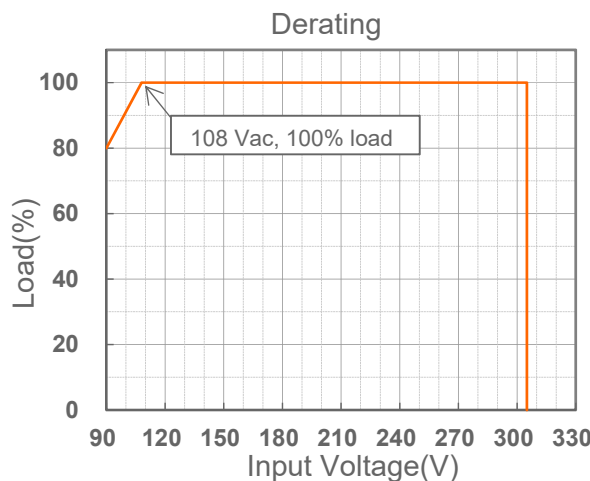

Lifetime vs. Case Temperature

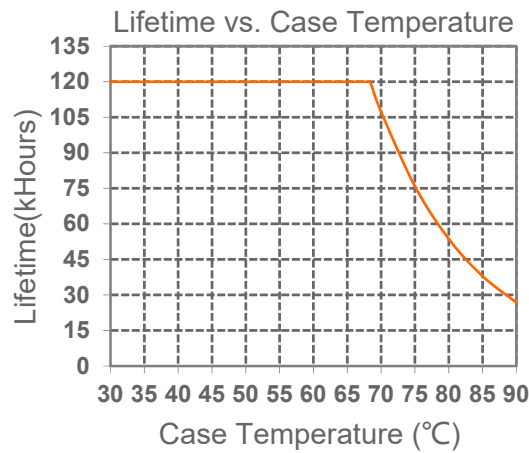

Inrush Current Waveform

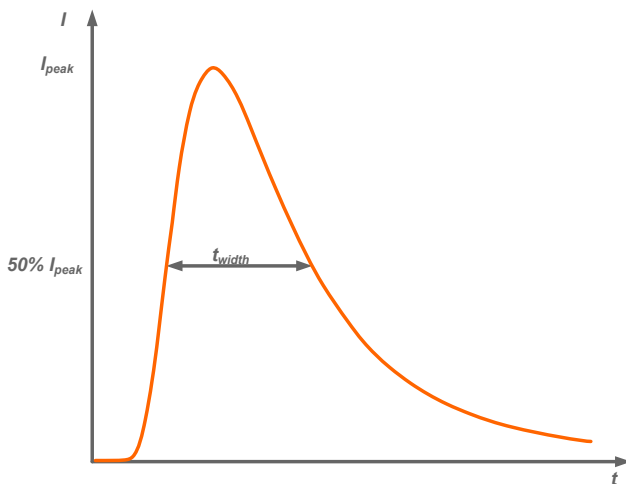

Input AC Voltage	I_{peak}	t_{width} (@ 50% I_{peak})
120Vac	7.00 A	3.60 ms
220Vac	14.0 A	4.16 ms
277Vac	16.7 A	4.08 ms

MCB	Tripping Curves	B	B	B	B	C	C	C	C
	Rated Current	10A	16A	20A	25A	10A	16A	20A	25A
The Number of LED Driver can be Configured	120Vac	0	1	1	2	1	1	2	2
	220Vac	1	2	3	4	2	3	4	5
	277Vac	1	3	3	4	2	4	5	6

Efficiency vs. Load

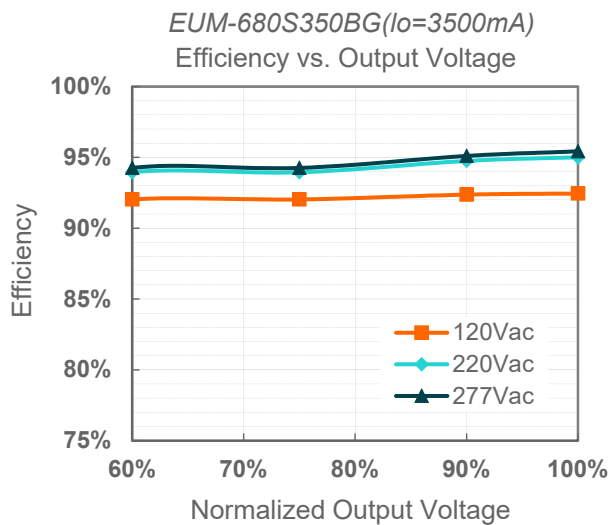
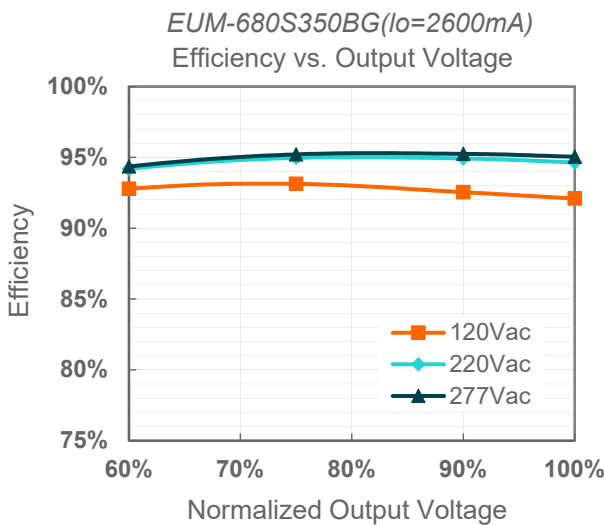
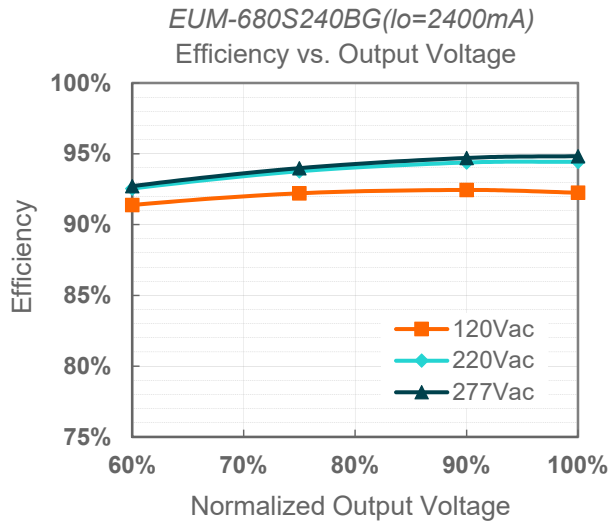
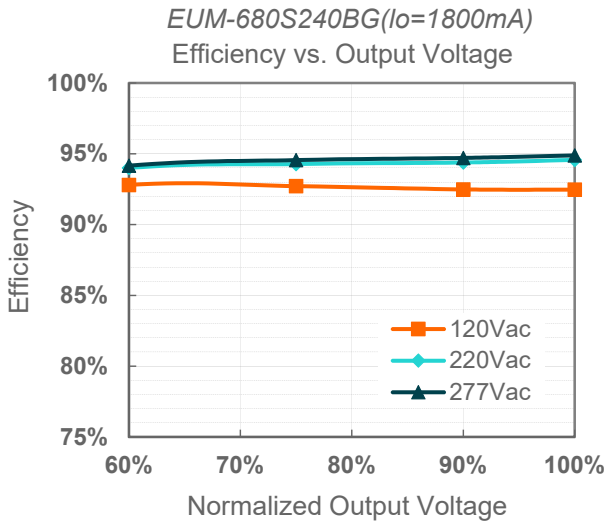
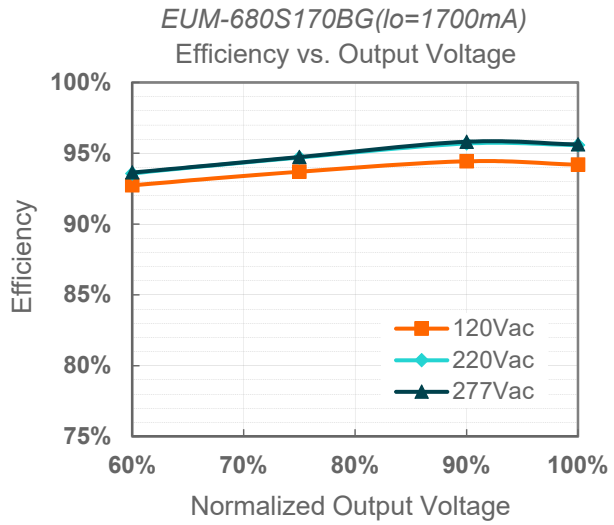
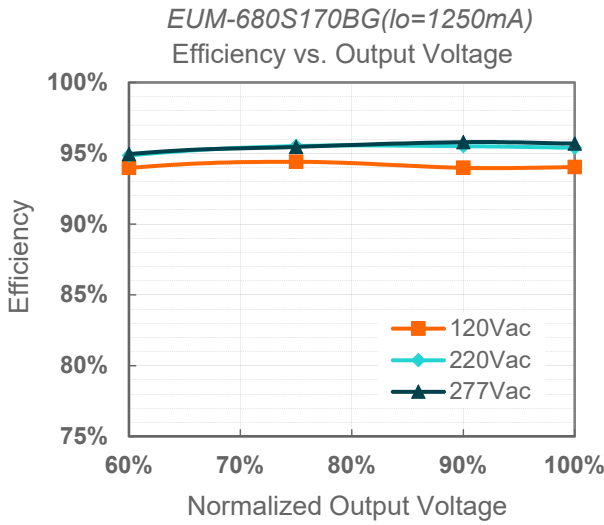

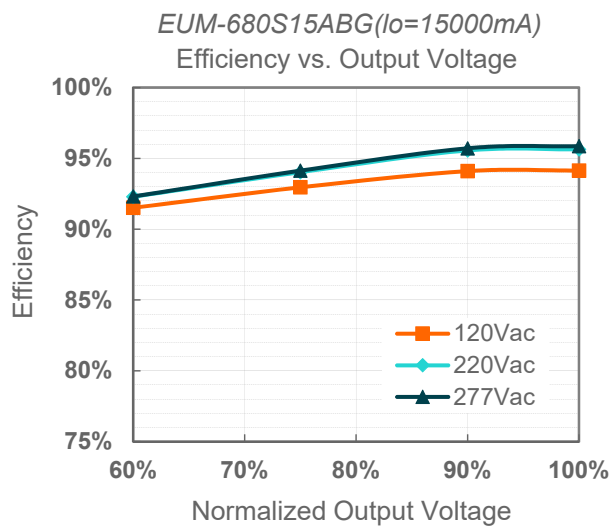
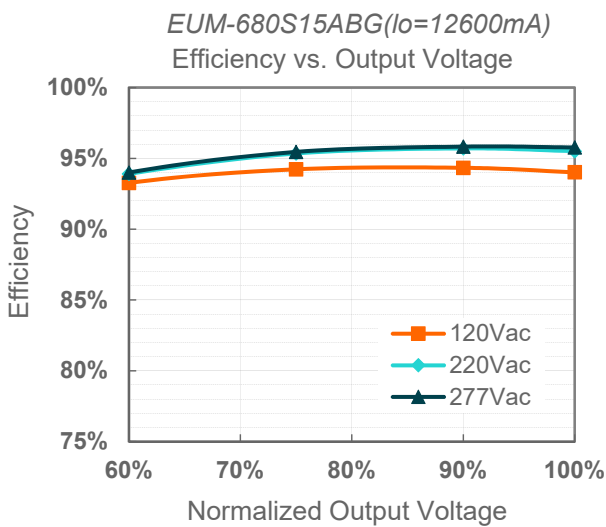
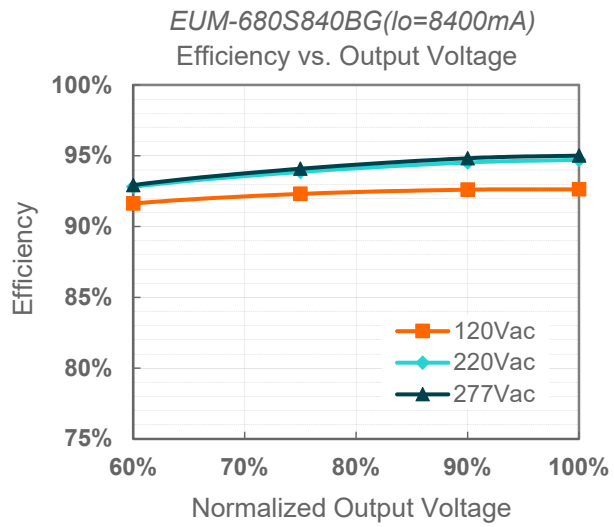
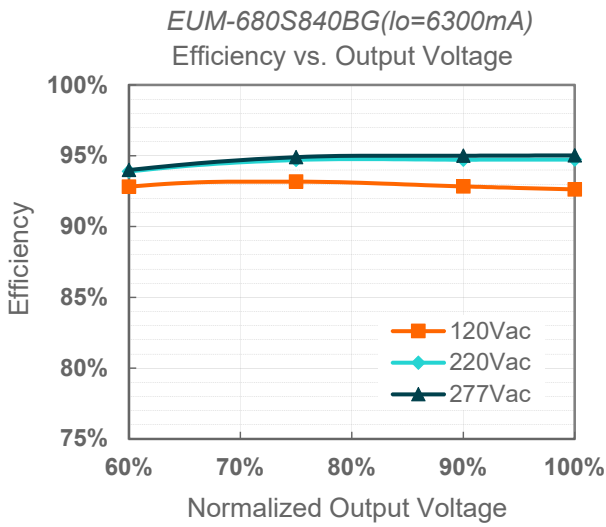
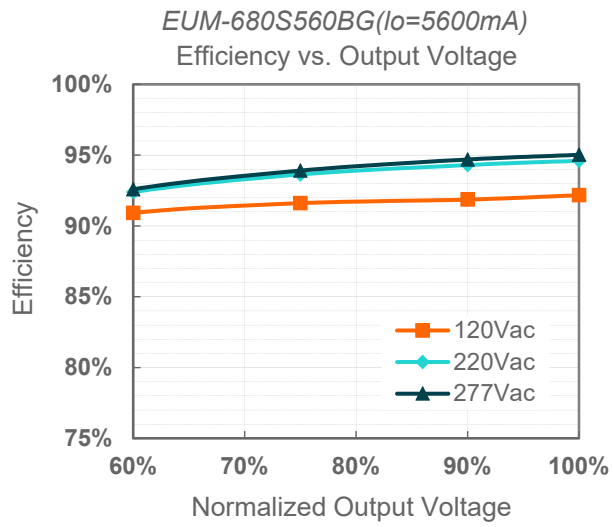
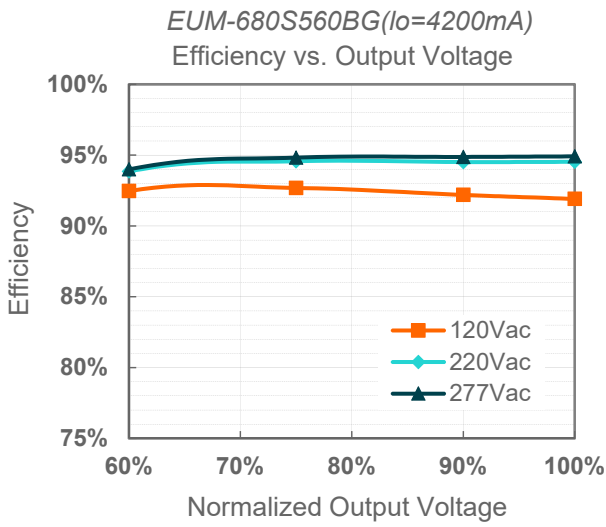

Power Factor

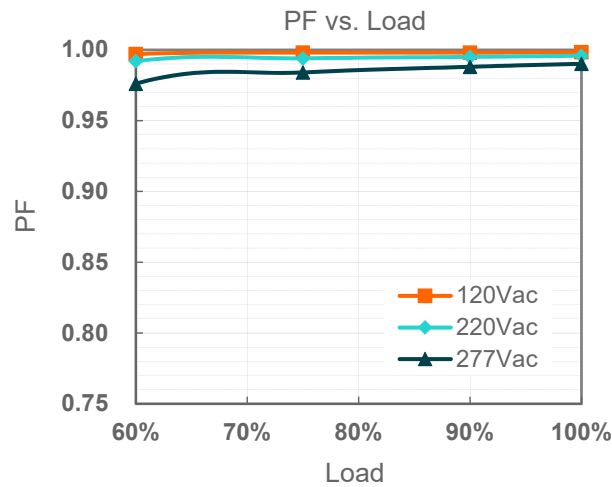

Total Harmonic Distortion

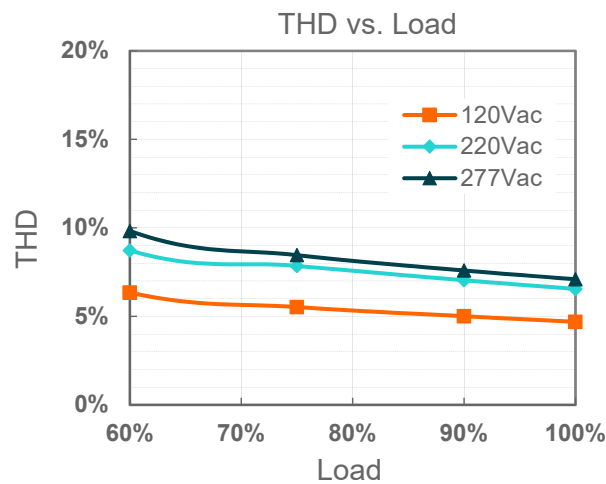

Protection Functions

Parameter		Min.	Typ.	Max.	Notes
External Thermal Protection	R1 (Start derating)	-	1.67 kΩ	-	The output current starts to decrease linearly when the actual NTC resistance value is lower than R1, until R2 is reached.
	R2 (Stop derating)	-	1.27 kΩ	-	When the actual NTC resistance value is lower than R2, the output current will stay at the programmed Protection Current Floor.
	Protection Current Setting Range	10%loset	20%loset	100%loset	10%loset > I _{omin} (default setting is 20%)
I _{omin}		20%loset	100%loset	10%loset ≤ I _{omin} (default setting is 20%)	
Over Temperature Protection		Decreases output current, returning to normal after over temperature is removed.			
Short Circuit Protection		Auto Recovery. No damage will occur when any output is short circuited. The output shall return to normal when the fault condition is removed.			
Over Voltage Protection		Limits output voltage at no load and in case the normal voltage limit fails.			
Input Under Voltage Protection (IUVP)	Input Protection Voltage	70 Vac	80 Vac	90 Vac	Turn off the output when the input voltage falls below protection voltage.
	Input Recovery Voltage	75 Vac	85 Vac	95 Vac	Auto Recovery. The driver will restart when the input voltage exceeds recovery voltage.

Protection Functions (Continued)

Parameter		Min.	Typ.	Max.	Notes
Input Over Voltage Protection (IOVP)	Input Over Voltage Protection	310 Vac	320 Vac	330 Vac	Turn off the output when the input voltage exceeds protection voltage.
	Input Over Voltage Recovery	300 Vac	310 Vac	320 Vac	Auto Recovery. The driver will restart when the input voltage falls below recovery voltage.
	Max. of Input Over Voltage	-	-	350 Vac	The driver can survive for 8 hours with a stable input voltage stress of 350Vac.

Note: (1) The recommended NTC type is 10kΩ NTC, Murata NCP18XH103J03RB.

● Input Under Voltage Protection Diagram

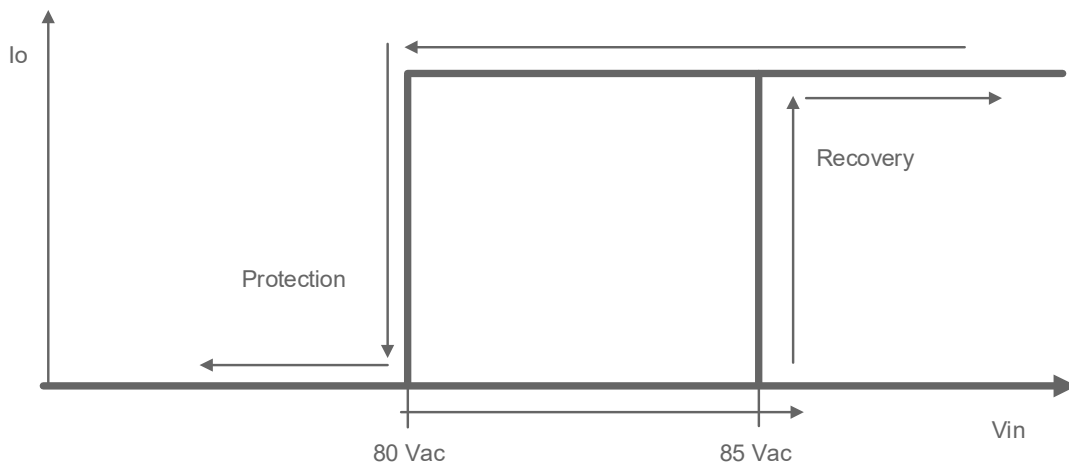

● Input Over Voltage Protection Diagram

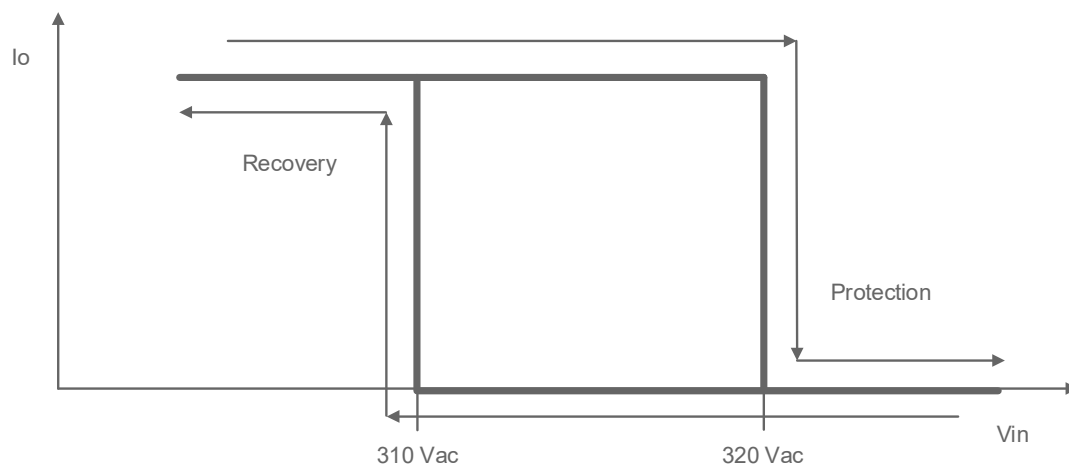

Dimming

● DALI-2 Dimming

The recommended implementation of the dimming control is provided below.

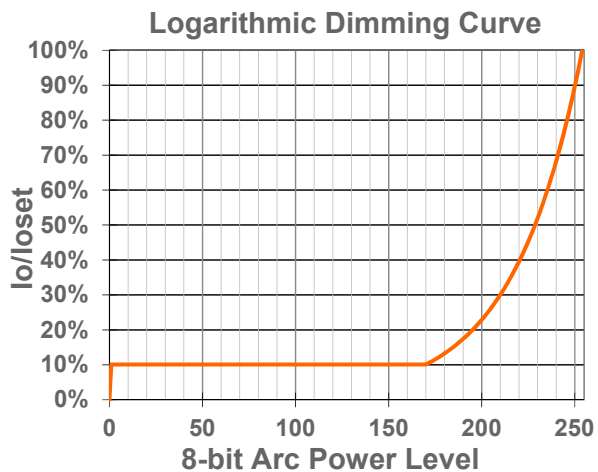
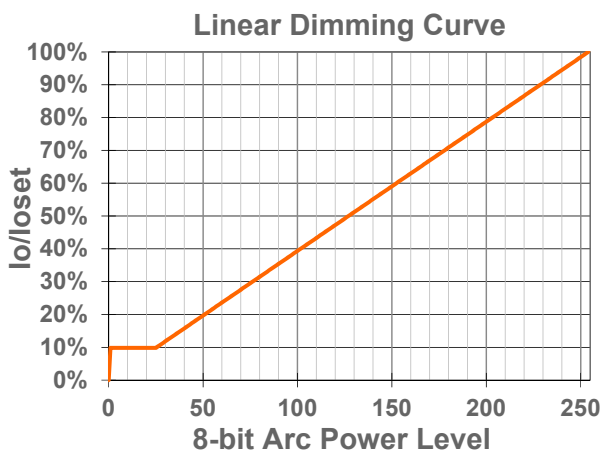
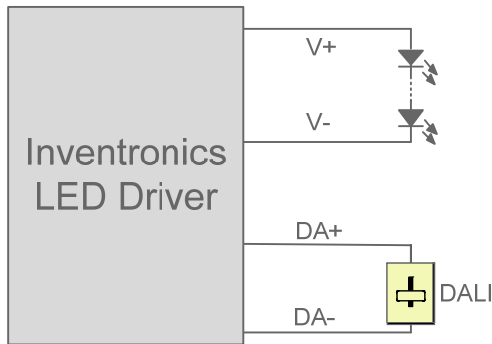

Implementation: DALI-2 Dimming

● Time Dimming

Time dimming control includes 3 kinds of modes, they are Self Adapting-Midnight, Self Adapting-Percentage and Traditional Timer.

- **Self Adapting-Midnight:** Automatically adjusts the dimming curve based on the on-time of past two days (if difference <15 minutes), assuming that the center point of the dimming curve is midnight local time.
- **Self Adapting-Percentage:** Automatically adjusts the on-time of each step by a constant percentage = (actual on-time for the past 2 days if difference <15 min) / (programmed on-time from the dimming curve).
- **Traditional Timer:** Follows the programmed timing curve after power on with no changes.

● Output Lumen Compensation

Output Lumen Compensation (OLC) may be used to maintain constant light output over the life of the LEDs by driving them at a reduced current when new, then gradually increasing the drive current over time to counteract LED lumen degradation.

● End Of Life

End-of-Life (EOL) is providing a visual notification to a user that the LED module has reached the end of manufacturer-specified life and that the replacement is recommended. Once active, an indication is given at each power-up of the driver, which the driver indicates this through a lower light output during the first 1 minute before normal operation is continued.

Programming Connection Diagram

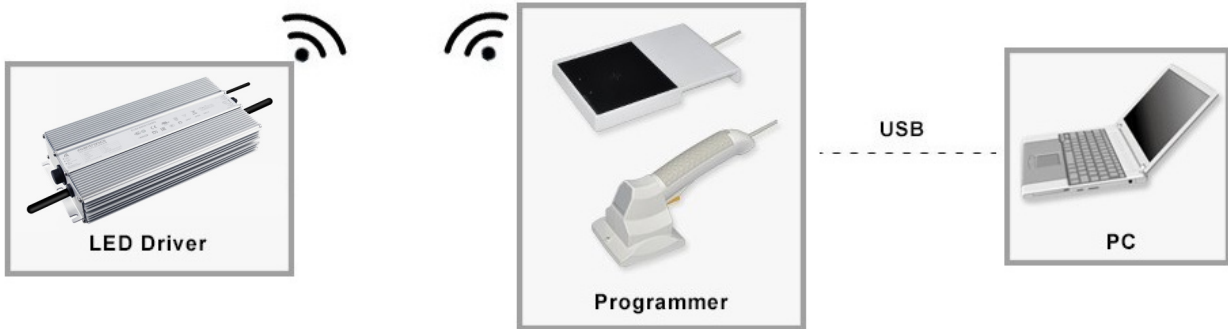

Note: The driver does not need to be powered on during the programming process.

- Please refer to [PRG-NFC-H](#) or [PRG-NFC-D2](#) (Programmer) datasheet for details.

Mechanical Outline

EUM-680S170BG/EUM-680S240BG

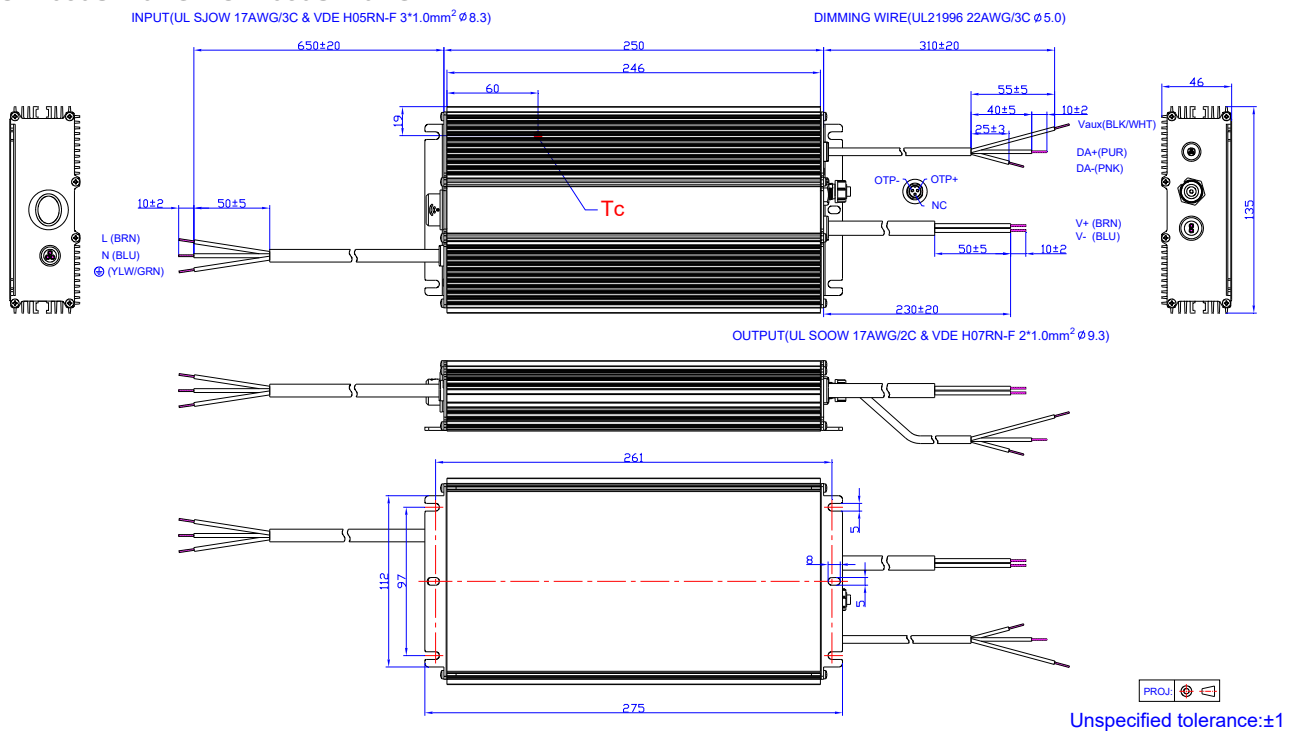

EUM-680S350BG/EUM-680S560BG/EUM-680S840BG

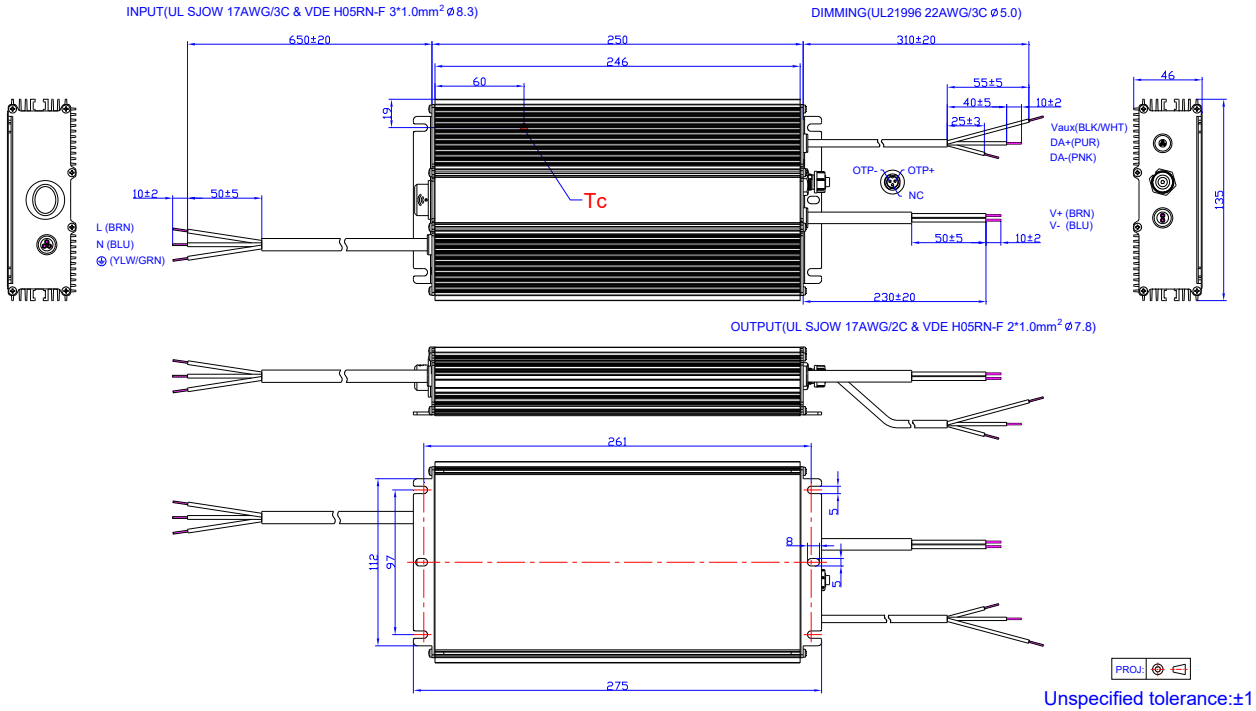

EUM-680S15ABG

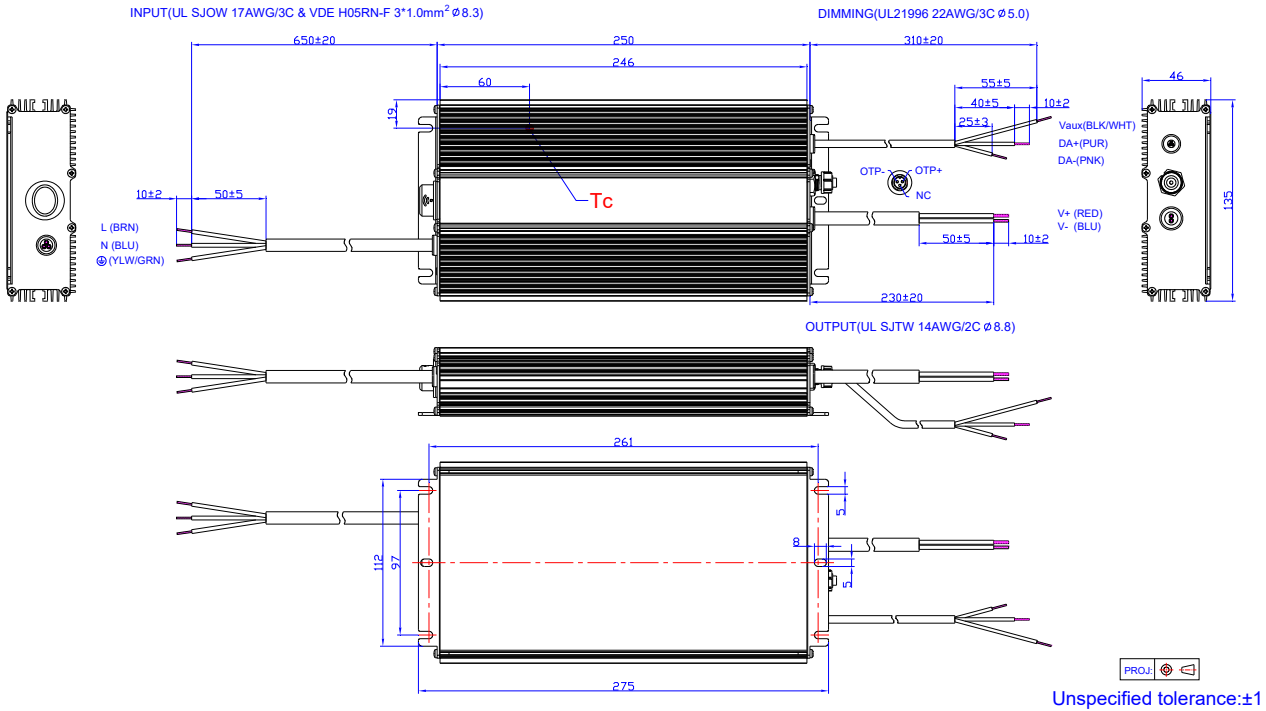

Optional Cable Parts

CAB-OTPG

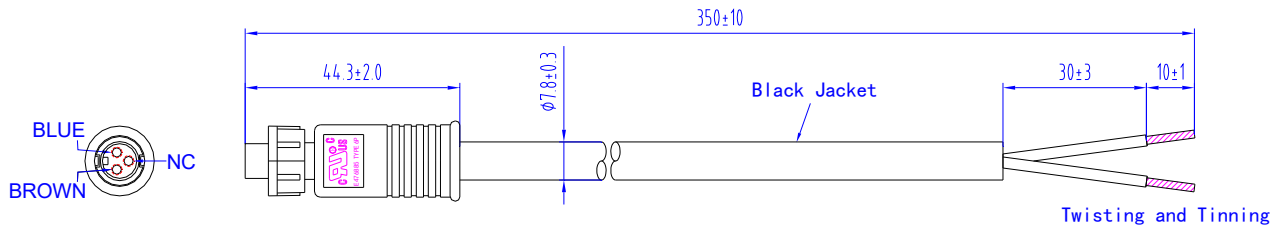

- The external thermal protection cable used for the EUM series drivers can be supplied by Inventronics, please contact the sales for ordering if necessary. For the details of cable, please refer to [CAB-OTPG \(Cable\)](#) datasheet.

RoHS Compliance

Our products comply with reference to RoHS Directive (EU) 2015/863 amending 2011/65/EU, calling for the elimination of lead and other hazardous substances from electronic products.

Revision History

Change Date	Rev.	Description of Change		
		Item	From	To
2022-03-11	A	Datasheet Release	/	/
2022-03-17	B	KCC/NOM	/	Deleted
2022-04-15	C	Features	/	Updated
		General Specifications	/	Updated
		Safety & EMC Compliance	/	Updated
2023-06-13	D	Product Photograph	/	Updated
		Output Specifications	/	Updated
		Safety & EMC Compliance	/	Updated
		Dimming	/	Updated
		Programming Connection Diagram	/	Updated
		Mechanical Outline	/	Updated
2024-10-25	E	Format	/	Updated
		Product Photograph	/	Updated
		UKCA logo	/	Deleted
		PSE logo	/	Added
		Safety & EMC Compliance	/	Updated
		Inrush Current Waveform	/	Updated