

Features

- Hot-plugging Protection
- Parallel LED Protection
- Ultra High Efficiency (Up to 96.5%)
- Full Power at Wide Output Current Range (Constant Power)
- Adjustable Output Current (AOC)with Programmability
- Isolated 0-10V/PWM/Resistor/3-Timer-Modes Dimmable
- Adjustable Dimming Curve
- INV Digital Dimming, UART Based Communication Protocol
- Dim-to-Off with Standby Power $\leq 0.5W$
- Minimum Dimming Level with 5% or 10% Selectable
- Hold Time Adjustable
- Fade Time Adjustable
- Always-on Auxiliary Power: 12Vdc, 250mA
- Low Inrush Current
- Output Lumen Compensation
- End-of-Life Indicator
- Input Surge Protection: DM 6kV, CM 10kV
- All-Around Protection: IOVP, IUVP, OVP, SCP, OTP
- IP66/IP67 and UL Dry/Damp/Wet Location
- TYPE HL, for Use in a Class I, Division 2 Hazardous (Classified) Location
- 5 Years Warranty



Description

The SUM-1K5SxxxMx series is a 1500W, constant-current, programmable and IP66/IP67 rated LED driver that operates from 90-305Vac input with excellent power factor. Created for many lighting applications including high mast, sports, UV-LED, aquaculture and horticulture, etc. It provides an auxiliary voltage and dim-to-off functionality for powering low voltage, wireless controls. The dimming control supports 0-10V dimming as well as two-way communication via Digital Dimming, a UART based communication protocol. The high efficiency of these drivers and compact metal case enables them to run cooler, significantly improving reliability and extending product life. To ensure trouble-free operation, protection is provided against input surge, input under voltage, input over voltage, output over voltage, short circuit, and over temperature.

Models

Adjustable Output Current Range (A)	Full-Power Current Range (A) ⁽¹⁾	Default Output Current (A)	Output Voltage Range (Vdc)	Max. Output Power (W)	Typical Efficiency ⁽²⁾	Typical Power Factor		Model Number ⁽³⁾
						120Vac	220Vac	
0.4-6.0	4.0-6.0	4.0	175-375	1500	96.0%	0.99	0.96	SUM-1K5S600Mx ⁽⁴⁾
1-12.5	10-12.5	11.5	84-150	1500	96.0%	0.99	0.96	SUM-1K5S12AMx ⁽⁴⁾
2.8-31.5	28-31.5	28	34-54	1500	96.0%	0.99	0.96	SUM-1K5S31AMx ⁽⁵⁾

Notes: (1) Output current range with constant power at 1500W.

(2) Measured at 100% load and 220Vac input (see below "General Specifications" for details).

- (3) Certified input voltage range: UL, FCC 100-277Vac; otherwise: 100-240Vac
- (4) x = G are UL Recognized, CE, CCC, global-mark, etc. models; x = T are UL Recognized, CE (built-in use), etc. models.
- (5) SELV output; x = G are UL Recognized, CE, etc. models; x = T are UL Recognized, CE (built-in use), etc. models.

I-V Operation Area

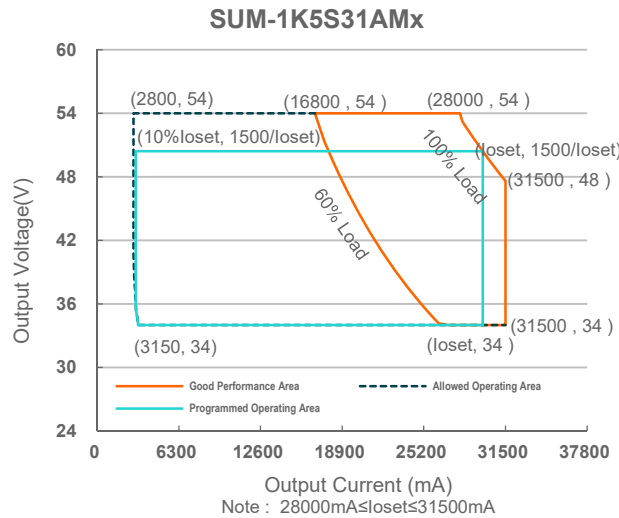
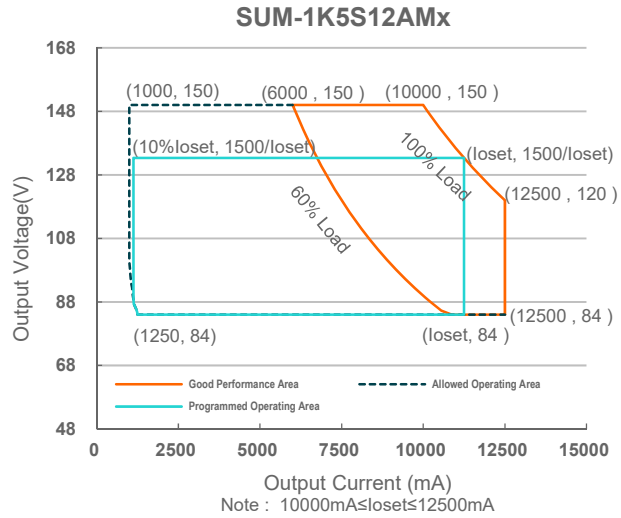
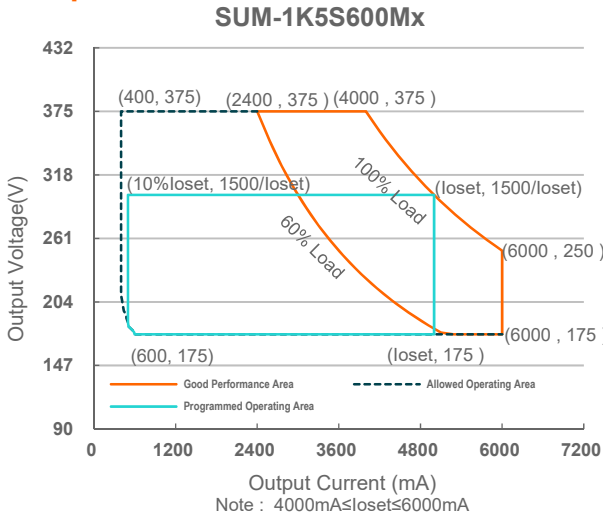

Input Specifications

Parameter	Min.	Typ.	Max.	Notes
Input AC Voltage	90 Vac	-	305 Vac	
Input DC Voltage	127 Vdc	-	300 Vdc	
Input Frequency	47 Hz	-	63 Hz	
Leakage Current	-	-	0.75 MIU	UL 8750; 277Vac/ 60Hz
			0.70 mA	IEC 60598-1; 240Vac/ 60Hz

Input Specifications (Continued)

Parameter	Min.	Typ.	Max.	Notes
Input AC Current	-	-	9.90 A	Measured at 1000W and 120 Vac input.
	-	-	8.03 A	Measured at 100% load and 220 Vac input.
Inrush Current(I ² t)	-	-	2.84 A ² s	At 220Vac input, 25°C cold start, duration=13.1 ms, 10%I _{pk} -10%I _{pk} .
PF	0.90	-	-	At 120-277Vac, 50-60Hz, 60%-100% Load (900 - 1500W)
THD	-	-	20%	
THD			10%	At 220-240Vac, 50-60Hz, 75%-100% Load (1125 - 1500W)

Output Specifications

Parameter	Min.	Typ.	Max.	Notes
Output Current Tolerance	-5%loset	-	5%loset	100% load
Output Current Setting(loset Range)				
SUM-1K5S600Mx	400 mA	-	6000 mA	
SUM-1K5S12AMx	1000 mA	-	12500 mA	
SUM-1K5S31AMx	2800 mA	-	31500 mA	
Output Current Setting Range with Constant Power				
SUM-1K5S600Mx	4000 mA	-	6000 mA	
SUM-1K5S12AMx	10000 mA	-	12500 mA	
SUM-1K5S31AMx	28000 mA	-	31500 mA	
Total Output Current Ripple (pk-pk)	-	5%lomax	10%lomax	100% load, 20 MHz BW
Output Current Ripple at < 200 Hz (pk-pk)	-	-	2%lomax	60%-100% load
Startup Overshoot Current	-	-	10%lomax	100% load
No Load Output Voltage				
SUM-1K5S600Mx	-	-	420 V	
SUM-1K5S12AMx	-	-	170 V	
SUM-1K5S31AMx	-	-	60 V	
Line Regulation	-	-	±0.5%	100% load
Load Regulation	-	-	±3.0%	
Turn-on Delay Time	-	-	0.5 s	Measured at 120-277Vac input, 60%-100% Load
Temperature Coefficient of loset	-	0.03%/°C	-	Case temperature = 0°C ~T _c max
12V Auxiliary Output Voltage	10.8 V	12 V	13.2 V	
12V Auxiliary Output Source Current	0 mA	-	250 mA	Return terminal is "Dim-"
12V Auxiliary Output Transient Peak Current@6W	-	-	500 mA	500mA peak for a maximum duration of 2.2ms in a 6.0ms period during which time the average should not exceed 250mA.
12V Auxiliary Output Transient Peak Current@10W	-	-	850 mA	850mA peak for a maximum duration of 1.3ms in a 5.2ms period during which time the average should not exceed 250mA.

General Specifications

Parameter	Min.	Typ.	Max.	Notes
Efficiency at 120 Vac input: SUM-1K5S600Mx Io= 4000 mA Io= 6000 mA SUM-1K5S12AMx Io= 10000 mA Io= 12500 mA SUM-1K5S31AMx Io= 28000 mA Io= 29400 mA	92.0% 90.5% 91.5% 91.0% 91.0% 91.0%	94.0% 92.5% 93.5% 93.0% 93.0% 93.0%	- - - - - -	Measured at 1000W and steady-state temperature in 25°C ambient; (Efficiency will be about 2.0% lower if measured immediately after startup.)
Efficiency at 220 Vac input: SUM-1K5S600Mx Io= 4000 mA Io= 6000 mA SUM-1K5S12AMx Io= 10000 mA Io= 12500 mA SUM-1K5S31AMx Io= 28000 mA Io= 31500 mA	94.0% 93.5% 94.0% 94.0% 94.0% 94.0%	96.0% 95.5% 96.0% 96.0% 96.0% 96.0%	- - - - - -	Measured at 100% load and steady-state temperature in 25°C ambient; (Efficiency will be about 2.0% lower if measured immediately after startup.)
Efficiency at 277 Vac input: SUM-1K5S600Mx Io= 4000 mA Io= 6000 mA SUM-1K5S12AMx Io= 10000 mA Io= 12500 mA SUM-1K5S31AMx Io= 28000 mA Io= 31500 mA	94.0% 94.0% 94.0% 94.5% 94.5% 94.0%	96.0% 96.0% 96.0% 96.5% 96.5% 96.0%	- - - - - -	Measured at 100% load and steady-state temperature in 25°C ambient; (Efficiency will be about 2.0% lower if measured immediately after startup.)
Standby Power	-	-	0.5 W	Measured at 230Vac/50Hz; Dimming off
MTBF	-	203,000 Hours	-	Measured at 220Vac input, 80%Load and 25°C ambient temperature (MIL-HDBK-217F)
Lifetime	-	104,000 Hours	-	Measured at 220Vac input, 80%Load and 70°C case temperature; See lifetime vs. Tc curve for the details
	-	57,000 Hours	-	Measured at 220Vac input, 100%Load and 40°C ambient temperature
Operating Case Temperature for Safety Tc_s	-40°C	-	+90°C	
Operating Case Temperature for Warranty Tc_w	-40°C	-	+80°C	Case temperature for 5 years warranty Humidity: 10%RH to 95%RH
Storage Temperature	-40°C	-	+85°C	Humidity: 5%RH to 95%RH
Dimensions Inches (L × W × H) Millimeters (L × W × H)	18.27 × 3.54 × 1.91 464 × 90 × 48.5			With mounting ear 19.25 × 3.54 × 1.91 489 × 90 × 48.5
Net Weight	-	4240 g	-	

Dimming Specifications

Parameter	Min.	Typ.	Max.	Notes	
Absolute Maximum Voltage on the Vdim (+) Pin	-20 V	-	20 V		
Source Current on Vdim (+) Pin	90 uA	100 uA	110 uA	Vdim(+) = 0 V	
Dimming Output Range with 10%-100% (Default)	SUM-1K5S600Mx SUM-1K5S12AMx SUM-1K5S31AMx	10%loset	-	loset	4000 mA ≤ loiset ≤ 6000 mA 10000 mA ≤ loiset ≤ 12500 mA 28000 mA ≤ loiset ≤ 31500 mA
	SUM-1K5S600Mx SUM-1K5S12AMx SUM-1K5S31AMx	400 mA 1000 mA 2800 mA	-	loset	400 mA ≤ loiset < 4000 mA 1000 mA ≤ loiset < 10000 mA 2800 mA ≤ loiset < 28000 mA
Dimming Output Range with 5%-100% (Settable)	SUM-1K5S600Mx SUM-1K5S12AMx SUM-1K5S31AMx	5%loset	-	loset	4000 mA ≤ loiset ≤ 6000 mA 10000 mA ≤ loiset ≤ 12500 mA 28000 mA ≤ loiset ≤ 31500 mA
	SUM-1K5S600Mx SUM-1K5S12AMx SUM-1K5S31AMx	200 mA 500 mA 1400 mA	-	loset	400 mA ≤ loiset < 4000 mA 1000 mA ≤ loiset < 10000 mA 2800 mA ≤ loiset < 28000 mA
Recommended Dimming Input Range	0 V	-	10 V	Default 0-10V dimming mode.	
Dim off Voltage	0.35 V	0.5 V	0.65 V		
Dim on Voltage	0.55 V	0.7 V	0.85 V		
Hysteresis	-	0.2 V	-		
PWM_in High Level	3 V	-	10 V	Dimming mode set to PWM in Inventronics Programing Software.	
PWM_in Low Level	-0.3 V	-	0.6 V		
PWM_in Frequency Range	200 Hz	-	3 KHz		
PWM_in Duty Cycle	1%	-	99%		
PWM Dimming off (Positive Logic)	3%	5%	8%		
PWM Dimming on (Positive Logic)	5%	7%	10%		
PWM Dimming off (Negative Logic)	92%	95%	97%		
PWM Dimming on (Negative Logic)	90%	93%	95%		
Hysteresis	-	2%	-		

Safety & EMC Compliance

Safety Category	Standard
UL/CUL	UL 8750, CAN/CSA-C22.2 No. 250.13
CE	EN 61347-1, EN 61347-2-13
CB	IEC 61347-1, IEC 61347-2-13
CCC	GB 19510.1, GB 19510.14
global-mark	AS/NZS 61347.1, AS/NZS 61347.2.13

Safety & EMC Compliance (Continued)

EMI Standards	Notes
EN IEC 55015/GB/T 17743 ⁽¹⁾	Conducted emission Test & Radiated emission Test
EN IEC 61000-3-2/GB 17625.1	Harmonic current emissions
EN 61000-3-3	Voltage fluctuations & flicker
FCC Part 15 ⁽¹⁾	ANSI C63.4 Class B
	This device complies with Part 15 of the FCC Rules. Operation is subject to the following two conditions: [1] this device may not cause harmful interference, and [2] this device must accept any interference received, including interference that may cause undesired Operation.
EMS Standards	Notes
EN 61000-4-2	Electrostatic Discharge (ESD): 8 kV air discharge, 4 kV contact discharge
EN 61000-4-3	Radio-Frequency Electromagnetic Field Susceptibility Test-RS
EN 61000-4-4	Electrical Fast Transient / Burst-EFT
EN 61000-4-5	Surge Immunity Test: AC Power Line: Differential Mode 6 kV, Common Mode 10 kV
EN 61000-4-6	Conducted Radio Frequency Disturbances Test-CS
EN 61000-4-8	Power Frequency Magnetic Field Test
EN 61000-4-11	Voltage Dips
EN 61547	Electromagnetic Immunity Requirements Applies To Lighting Equipment

Note: (1) This LED driver meets the EMI specifications above, but EMI performance of a luminaire that contains it depends also on the other devices connected to the driver and on the fixture itself.

Derating

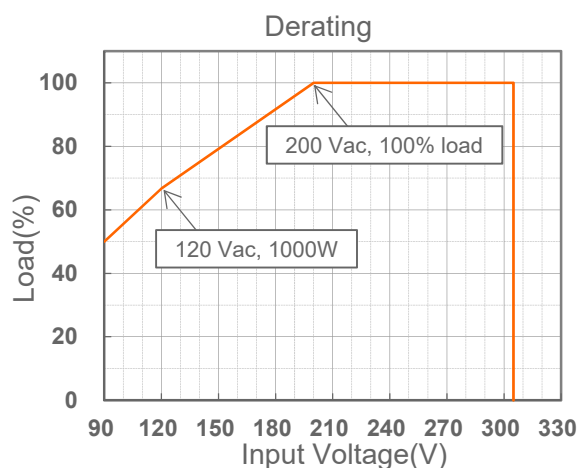

Lifetime vs. Case Temperature

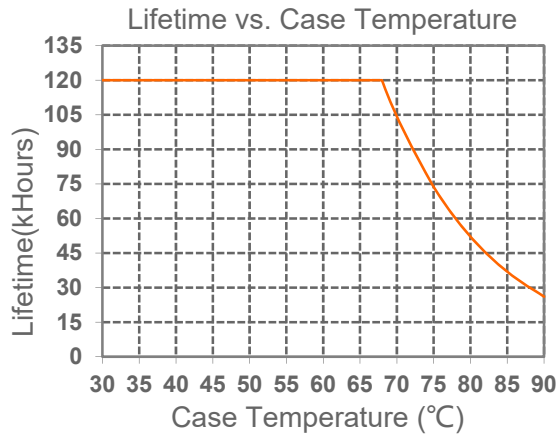

Inrush Current Waveform

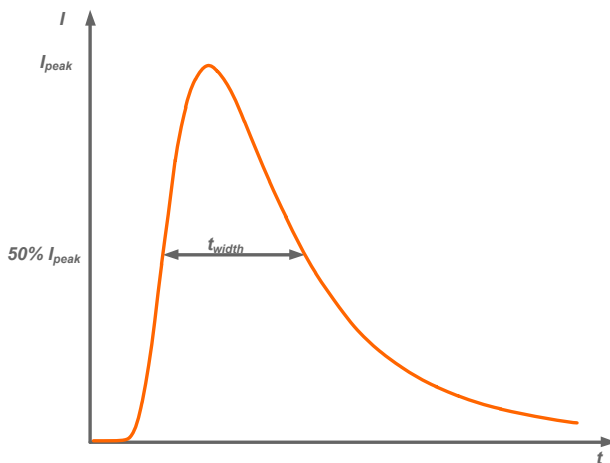

Input AC Voltage	I_{peak}	t_{width} (@ 50% I_{peak})
120Vac	8.60A	2.40ms
220Vac	17.0A	3.80ms
277Vac	21.6A	4.96ms

MCB	Tripping Curves	B	B	B	B	C	C	C	C
	Rated Current	10A	16A	20A	25A	10A	16A	20A	25A
The Number of LED Driver can be Configured	120Vac	0	0	0	1	0	0	1	1
	220Vac	0	1	1	2	0	1	1	2
	277Vac	1	1	2	2	1	1	2	3

Efficiency vs. Load

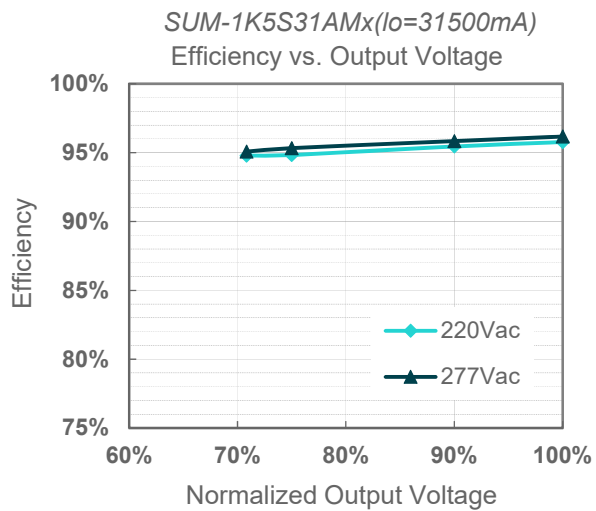
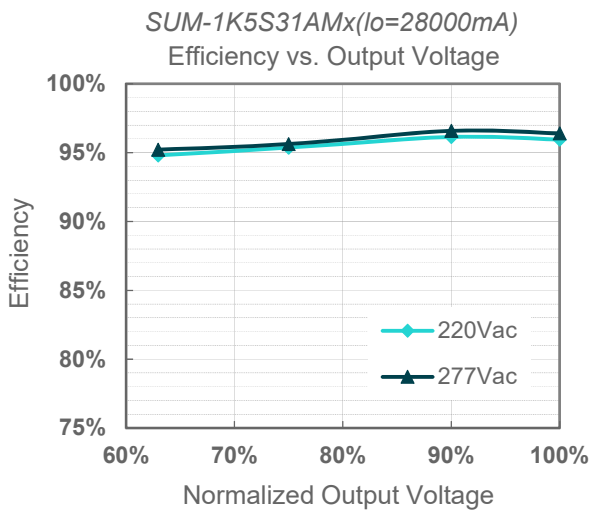
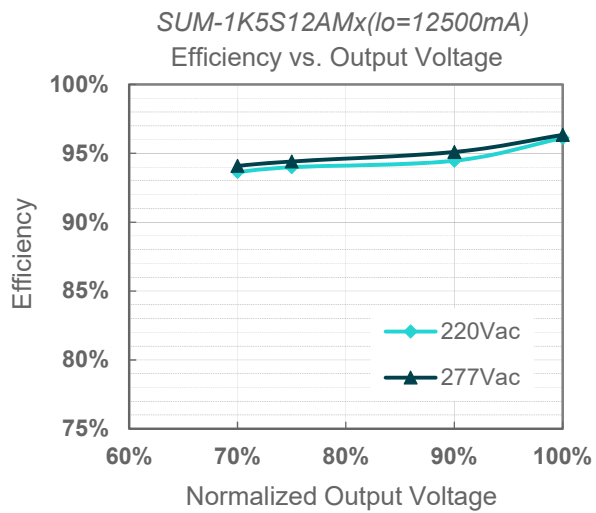
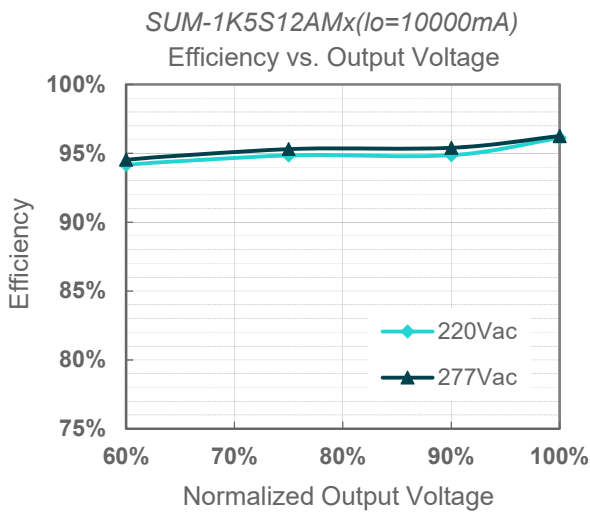
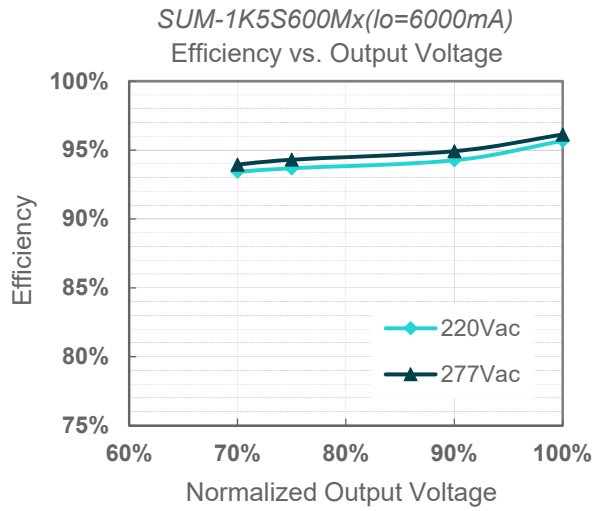
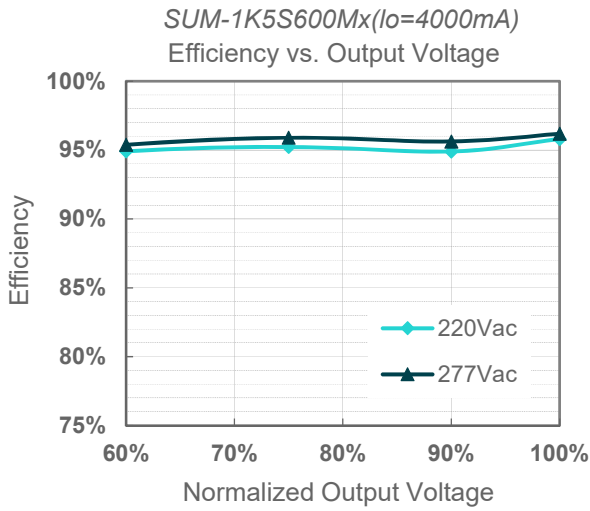

Power Factor

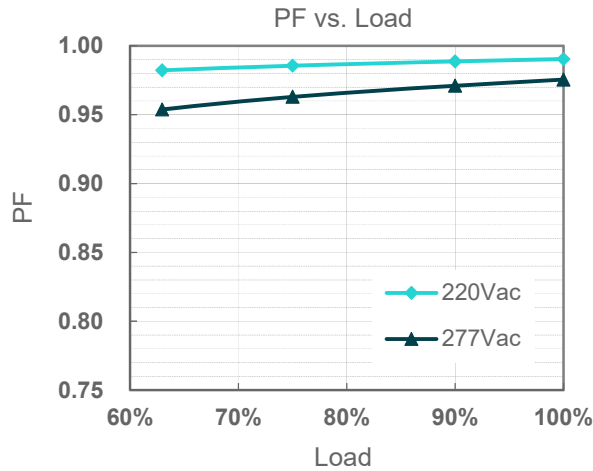

Total Harmonic Distortion

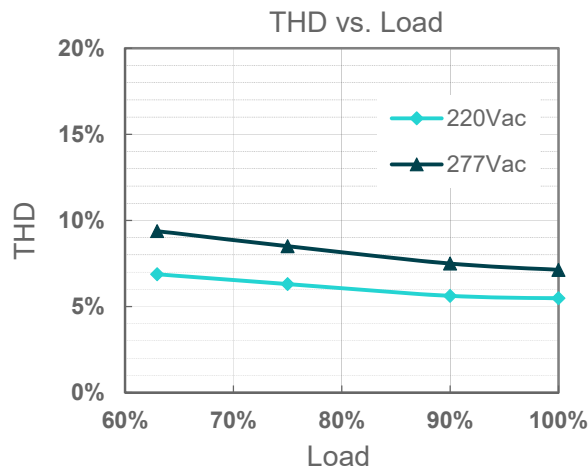

Hot-plugging Protection

This feature protects LEDs when connecting to a driver that is already powered on. This is disabled by default and can be enabled through the Inventronics Programming Software.

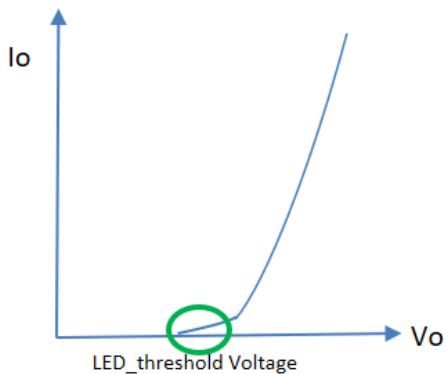

LED threshold voltage (V_{th}) is the minimum voltage required for current to flow through the LED load. After this threshold is met, the LED forward voltage (V_f) increases as the current increases.

Set V_{th} close to, but higher than the actual LED threshold voltage for optimized performance. The greater the difference between the V_{th} setting and the actual LED threshold voltage, the higher the overshoot current will be. The V_{th} setting must be lower than V_f .

Please test, program, and tune this feature for each LED load design.

Hot-plugging Protection (Continued)

Parameter		Min.	Typ.	Max.	Notes	
Hot-plugging Protection	LED Threshold Voltage Setting Range	SUM-1K5S600Mx	175V	-	375V	Set Vth close to, but higher than the actual LED threshold voltage
		SUM-1K5S12AMx	84V	-	150V	
		SUM-1K5S31AMx	44V	-	54V	
	Setting Tolerance		-2%	-	2%	

Parallel LED Protection

This feature helps protect parallel LEDs from a high, overcurrent condition by limiting the voltage. This is disabled by default and can be enabled through the Inventronics Programming Software.

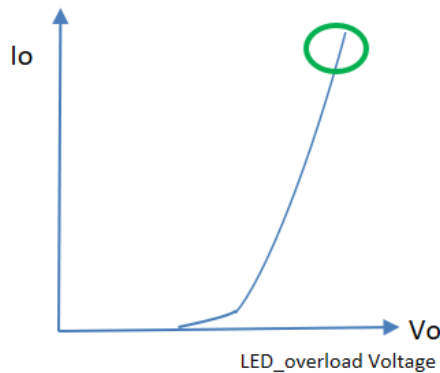

Set $V_{overload}$ close to, but higher than the maximum forward voltage for optimized performance. The greater the difference between the $V_{overload}$ setting and the maximum forward voltage, the higher the overload stress will be. The $V_{overload}$ setting must be higher than V_f .

Please test, program, and tune this feature for each LED load design.

Parameter		Min.	Typ.	Max.	Notes	
Parallel LED Protection	Overload Voltage Setting Range	SUM-1K5S600Mx	175V	-	390V	Set $V_{overload}$ close to, but higher than the maximum LED forward voltage
		SUM-1K5S12AMx	84V	-	160V	
		SUM-1K5S31AMx	47V	-	56V	
	Setting Tolerance		-2%	-	2%	

Protection Functions

Parameter	Notes
Over Voltage Protection	Limits output voltage at no load and in case the normal voltage limit fails.
Short Circuit Protection	Auto Recovery. No damage will occur when any output is short circuited. The output shall return to normal when the fault condition is removed.
Over Temperature Protection	Decreases output current, returning to normal after over temperature is removed.

Protection Functions (Continued)

Parameter		Min.	Typ.	Max.	Notes
Input Under Voltage Protection (IUVP)	Input Under Voltage Protection	70 Vac	80 Vac	90 Vac	Turn off the output when the input voltage falls below protection voltage.
	Input Under Voltage Recovery	75 Vac	85 Vac	95 Vac	Auto Recovery. The driver will restart when the input voltage exceeds recovery voltage.
Input Over Voltage Protection (IOVP)	Input Over Voltage Protection	310 Vac	320 Vac	330 Vac	Turn off the output when the input voltage exceeds protection voltage.
	Input Over Voltage Recovery	300 Vac	310 Vac	320 Vac	Auto Recovery. The driver will restart when the input voltage falls below recovery voltage.
	Max. of Input Over Voltage	-	-	350 Vac	The driver can survive for 8 hours with a stable input voltage stress of 350Vac.

● Input Under Voltage Protection Diagram

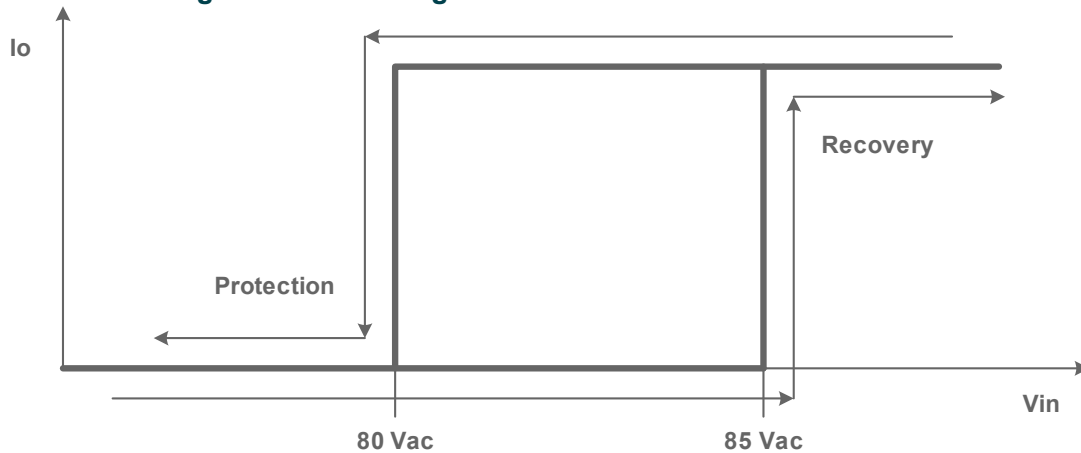

● Input Over Voltage Protection Diagram

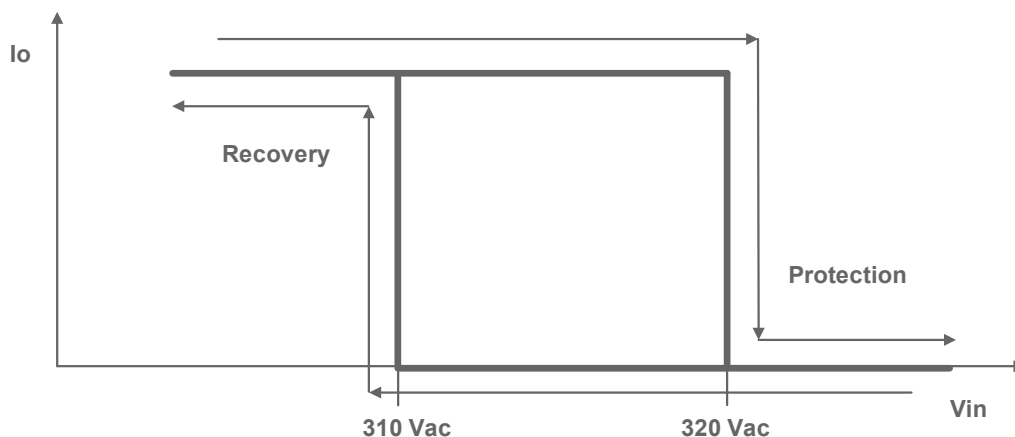

Dimming

● 0-10V Dimming

The recommended implementation of the dimming control is provided below.

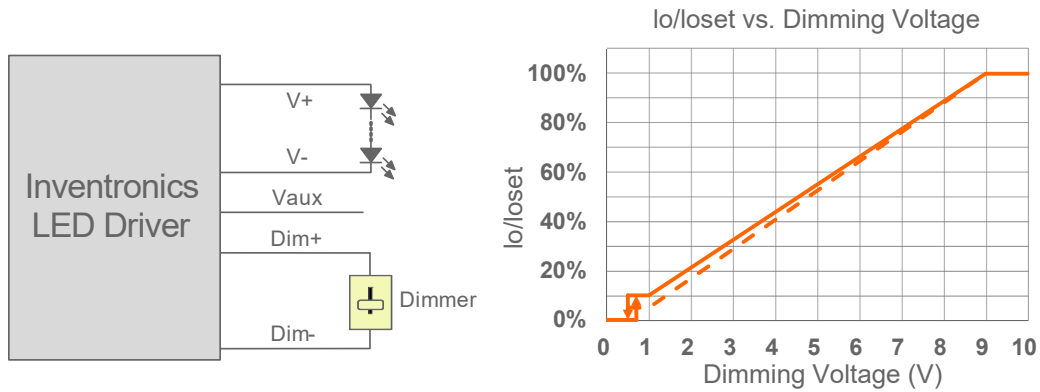

Implementation 1: Positive logic

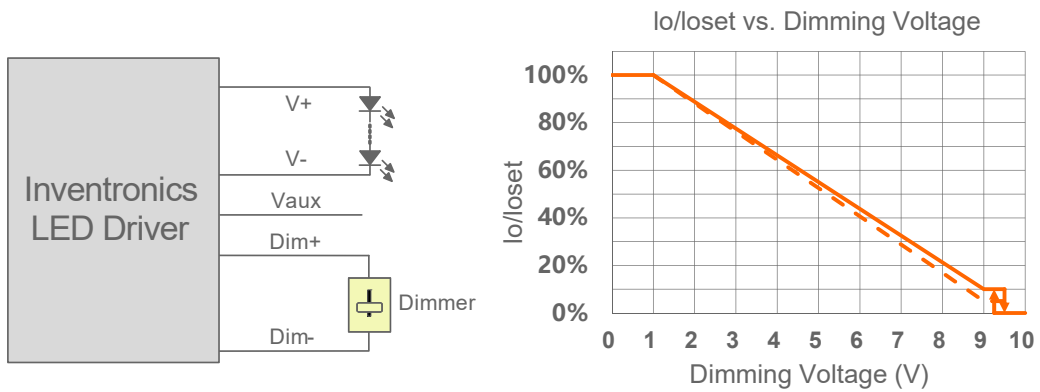

Implementation 2: Negative logic

Notes:

1. Do NOT connect Dim- to the output V- or V+, otherwise the driver will not work properly.
2. The dimmer can also be replaced by an active 0-10V voltage source signal or passive components like zener.
3. When 0-10V negative logic dimming mode and Dim+ is open, the driver will dim to off and be standby.

● PWM Dimming

The recommended implementation of the dimming control is provided below.

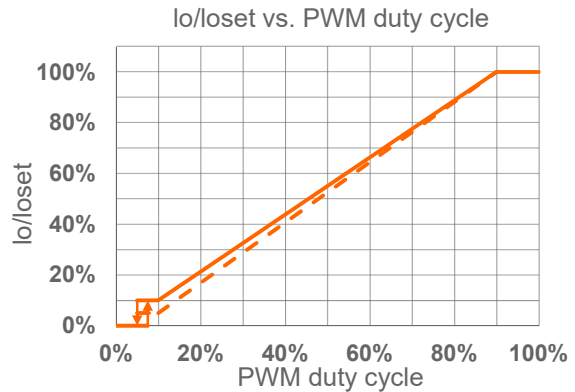
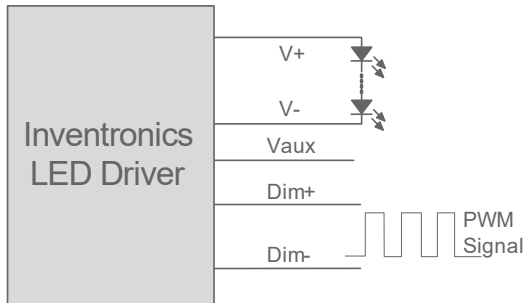

Implementation 3: Positive logic

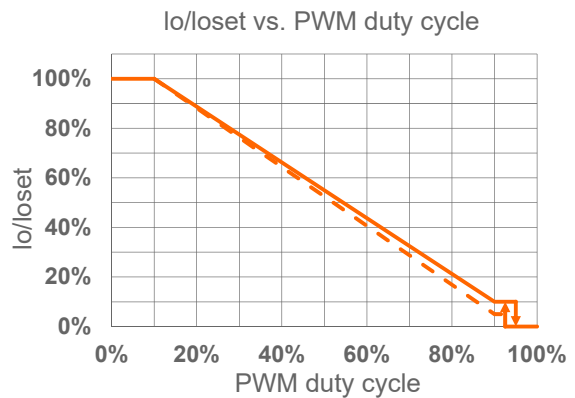
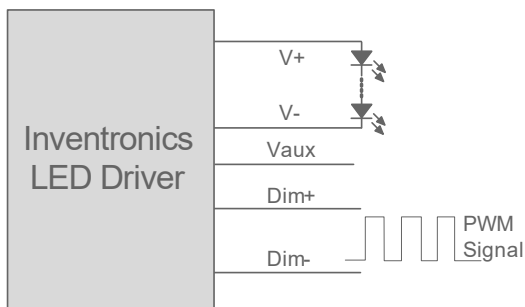

Implementation 4: Negative logic

Note:

1. Do NOT connect Dim- to the output V- or V+, otherwise the driver will not work properly.
2. When PWM negative logic dimming mode and Dim+ is open, the driver will dim to off and be standby.

● Resistor Dimming

The recommended implementation of the dimming control is provided below.

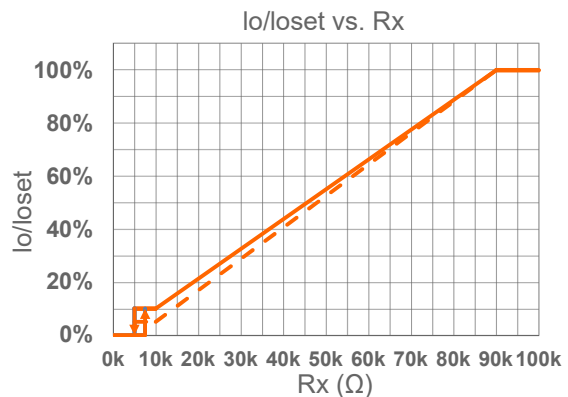
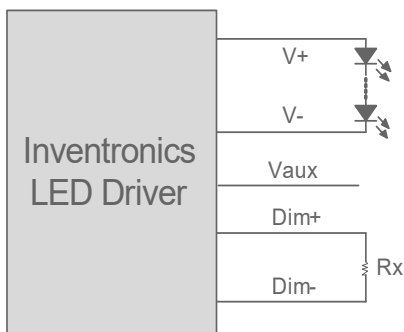

Implementation 5: Positive logic

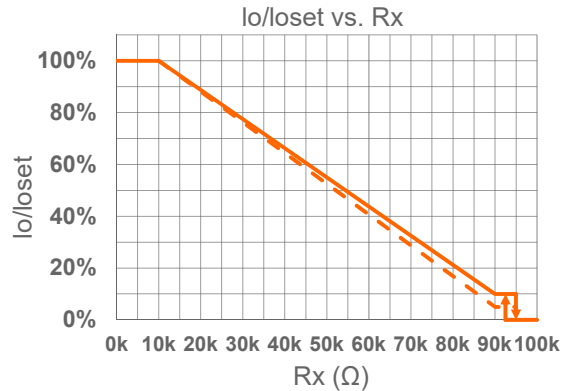
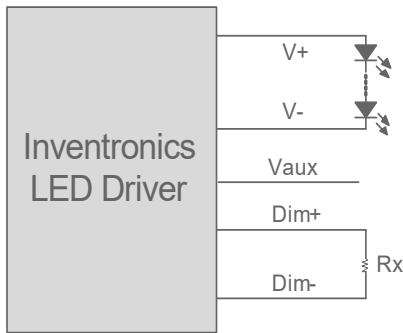

Implementation 6: Negative logic

Notes:

1. Do NOT connect Dim- to the output V- or V+, otherwise the driver will not work properly.
2. When resistor negative logic dimming mode and Dim+ is open, the driver will dim to off and be standby.

● Adjustable Dimming Curve

0-10V dimming curve can be set as corresponding dimming voltage by Inventronics Multi Programmer. Take the positive logic dimming as an example, the recommended implementation of the dimming control is provided below.

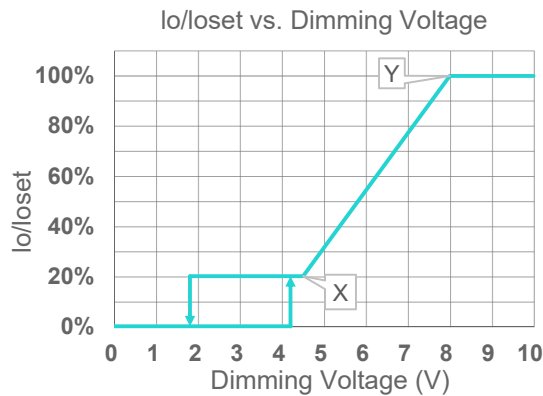
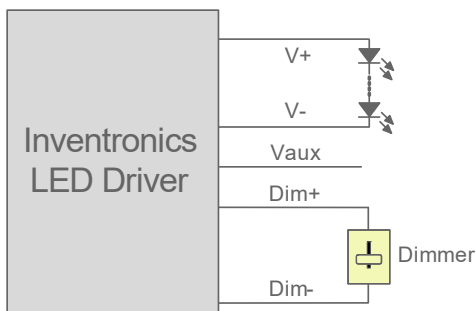

Implementation 7: Positive logic

Notes:

1. Do NOT connect Dim- to the output V- or V+, otherwise the driver will not work properly.
2. The dimmer can also be replaced by an active 0-10V voltage source signal or passive components like zener.
3. When dimming voltage X point is set to be smaller than Y point, the dimming curve is positive logic, conversely, when X point is set to be bigger than Y point, the dimming curve is negative logic.
4. For best dimming accuracy, the difference between X point and Y point is advised more than 4V.
5. Dimming off voltage adjustable.

● Time Dimming

Time dimming control includes 3 kinds of modes, they are Self Adapting-Midnight, Self Adapting-Percentage and Traditional Timer.

- **Self Adapting-Midnight:** Automatically adjusts the dimming curve based on the on-time of past two days (if difference <15 minutes), assuming that the center point of the dimming curve is midnight local time.
- **Self Adapting-Percentage:** Automatically adjusts the on-time of each step by a constant percentage = (actual on-time for the past 2 days if difference <15 min) / (programmed on-time from the dimming curve).
- **Traditional Timer:** Follows the programmed timing curve after power on with no changes.

- **Output Lumen Compensation**

Output Lumen Compensation (OLC) may be used to maintain constant light output over the life of the LEDs by driving them at a reduced current when new, then gradually increasing the drive current over time to counteract LED lumen degradation.

- **Minimum Dimming Level with 5% or 10% Selectable**

The minimum dimming level can be set as 5% or 10% by Inventronics Multi Programmer, 10% is default.

- **Hold Time Adjustable**

When AC power is first applied to the LED driver, enabling a “Hold” period can allow devices powered by the Auxiliary voltage to stabilize before the driver fades up to the maximum dimming level. During this period, the driver will not respond to external dimming commands but will respond again after the hold time ends. Both the initial dimming percentage and the duration of this hold period can be adjusted by the Inventronics Multi Programmer. This function is disabled by default

- **Fade Time Adjustable**

There is a “Fade” period after the “Hold” period. The soft-start time and dimming slope applied to all dimming transitions can be adjusted individually. It is adjusted by the Inventronics Multi Programmer. This function is disabled by default.

- **End Of Life**

End-of-Life (EOL) is providing a visual notification to a user that the LED module has reached the end of manufacturer-specified life and that the replacement is recommended. Once active, an indication is given at each power-up of the driver, which the driver indicates this through a lower light output during the first 1 minute before normal operation is continued.

- **Digital Dimming**

Inventronics Digital Dimming is a UART (Universal Asynchronous Receive Transmitter) based communication protocol. Please refer to [Inventronics Digital Dimming](#) file for details.

Programming Connection Diagram

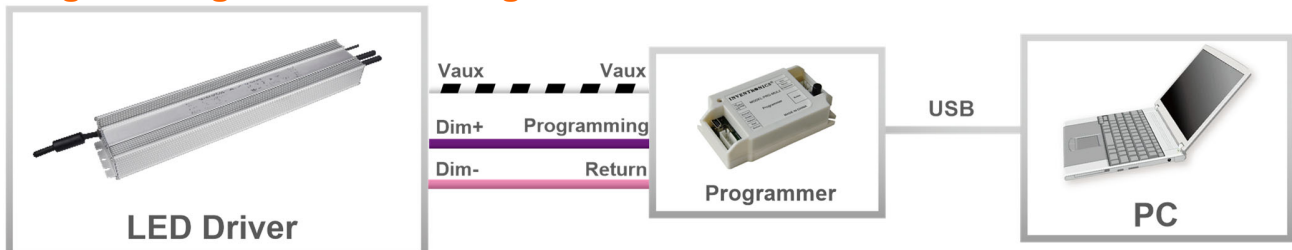

Note: The driver does not need to be powered on during the programming process.

- **Please refer to [PRG-MUL2](#) (Programmer) datasheet for details.**

Mechanical Outline

SUM-1K5S600MG

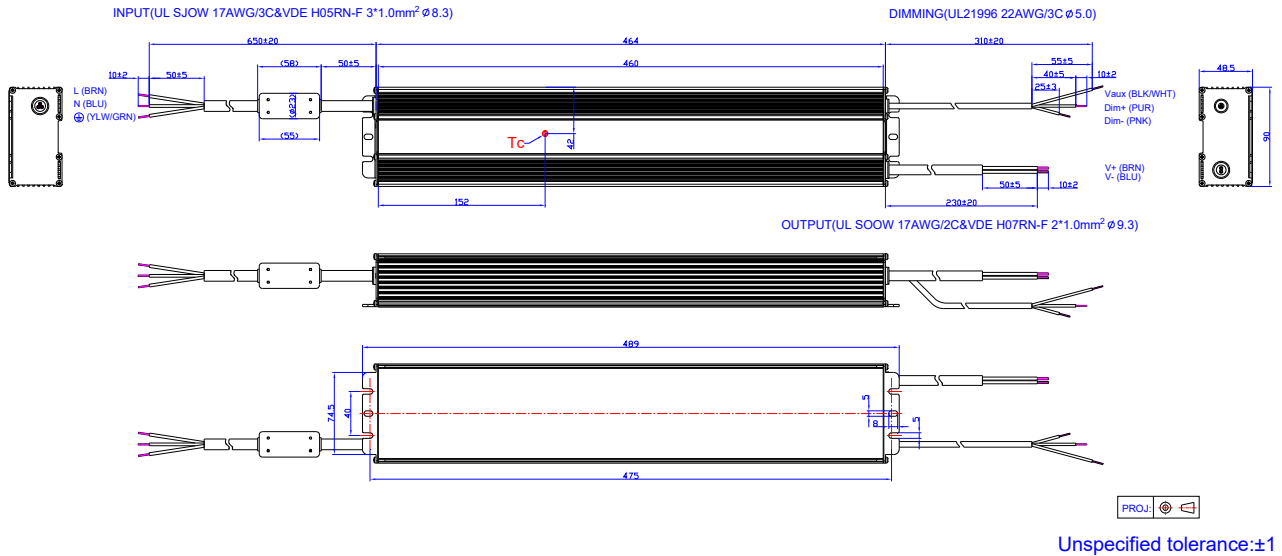

SUM-1K5S12AMG

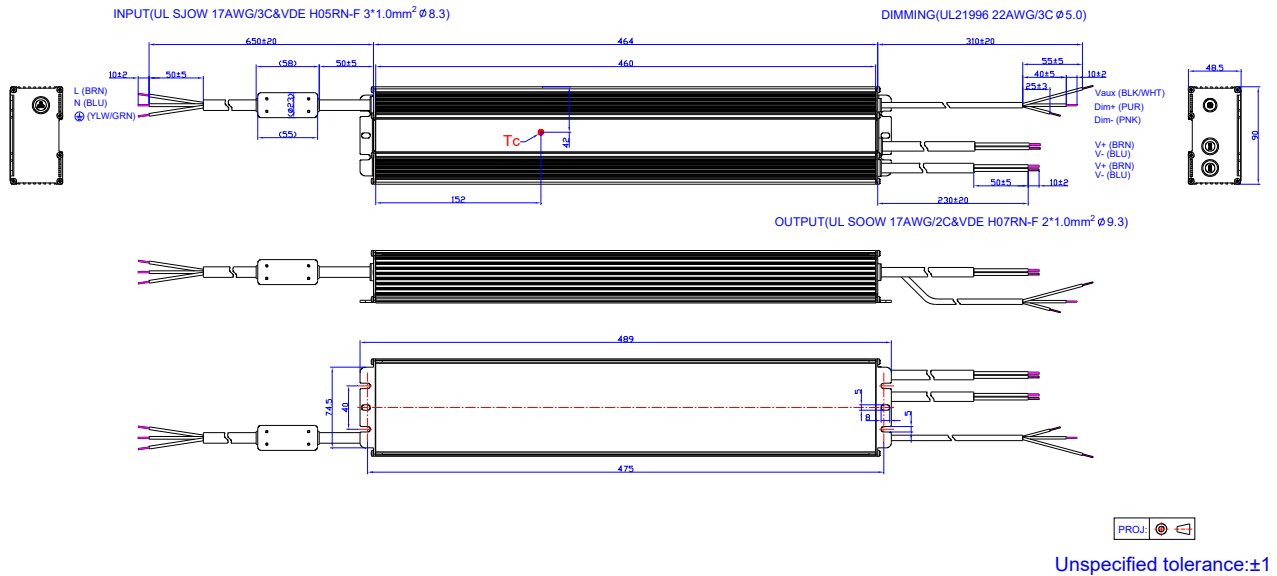

Note: The 2 DC output cables are connected in parallel internally because one 17AWG wire can only carry 8A. Please connect the 2 brown wires together and 2 blue wires together in application, and ensure each cable carries same current.

SUM-1K5S31AMG

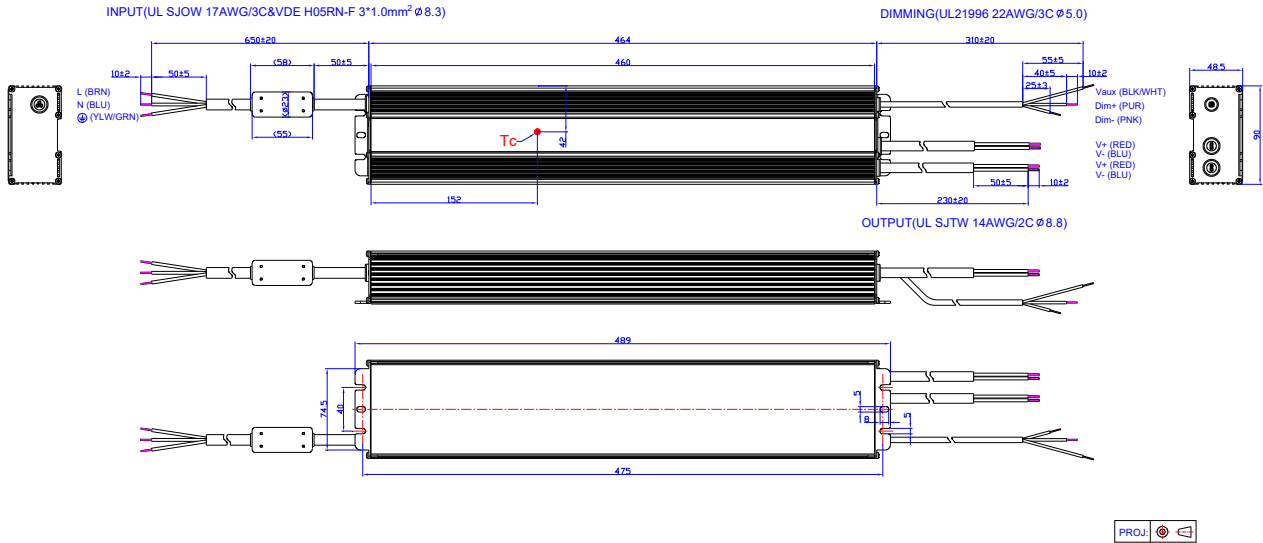

Unspecified tolerance: ±1

Note: The 2 DC output cables are connected in parallel internally because one 14AWG wire can only carry 16A. Please connect the 2 red wires together and 2 blue wires together in application, and ensure each cable carries same current.

SUM-1K5S600MT

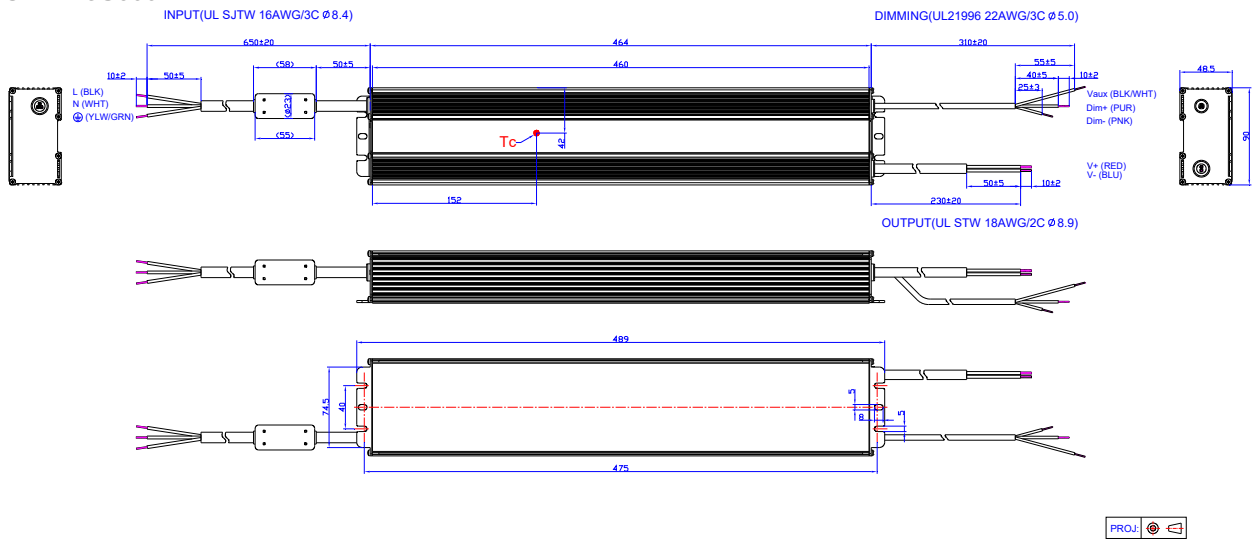

Unspecified tolerance: ±1

SUM-1K5S12AMT

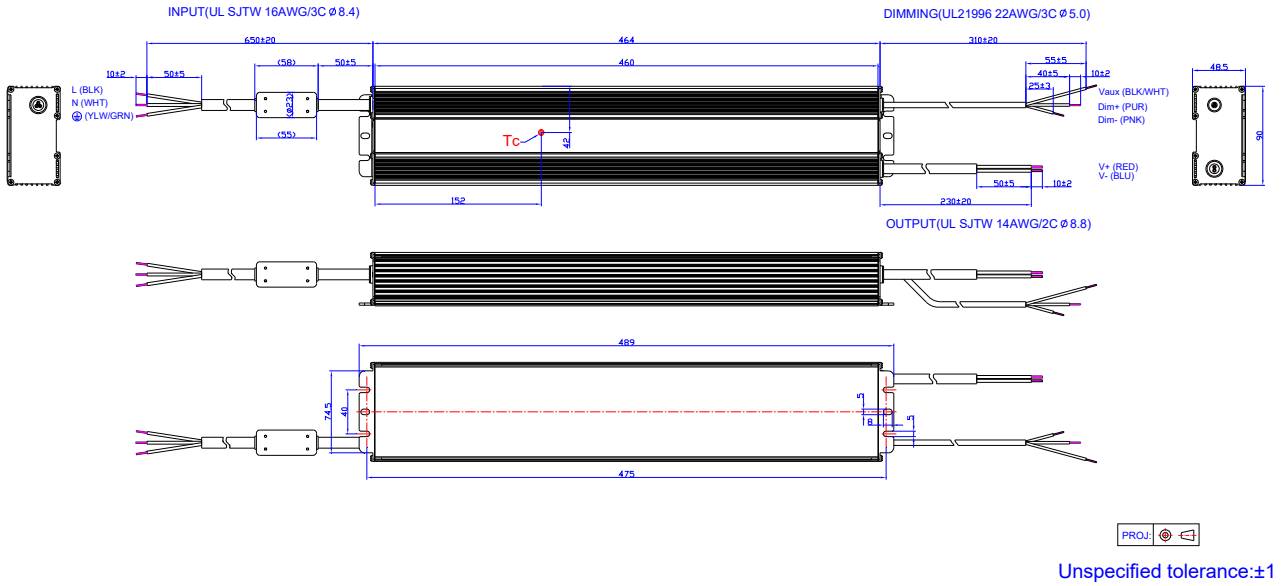

SUM-1K5S31AMT

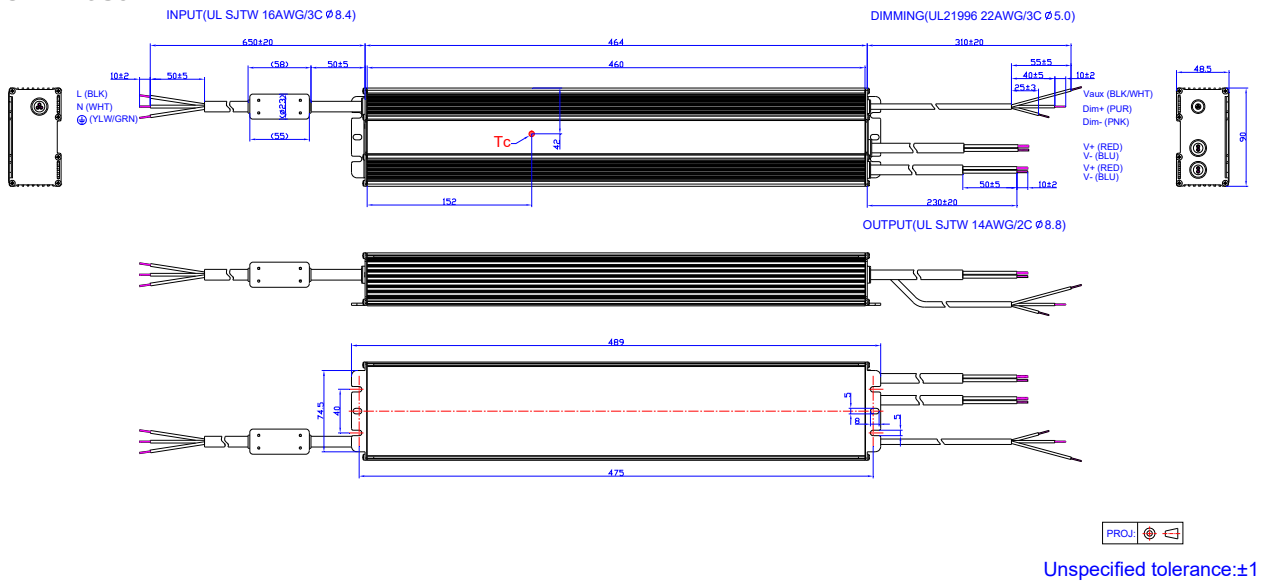

Note: The 2 DC output cables are connected in parallel internally because one 14AWG wire can only carry 16A. Please connect the 2 red wires together and 2 blue wires together in application, and ensure each cable carries same current.

RoHS Compliance

Our products comply with reference to RoHS Directive (EU) 2015/863 amending 2011/65/EU, calling for the elimination of lead and other hazardous substances from electronic products.

Revision History

Change Date	Rev.	Description of Change		
		Item	From	To
2022-12-13	A	Datasheet Release	/	/
2023-05-25	B	SUM-1K5S600Mx	/	Add
		Models	Note (4)/(5)	Updated
		Safety &EMC Compliance	/	Updated
2024-01-04	C	Format	/	Updated
		Features	/	Updated
		Inrush Current Waveform	/	Updated
		Dimming	/	Updated
2024-06-25	D	Input Specifications	/	Updated
		Inrush Current Waveform	/	Updated