

## LUD-050S140MTF

### Dimmable Constant Current LED Power Supply

Inventronics LUD Power Supply is the reliable choice for linear and area fixtures for office - industrial – shop – retail

#### Benefits

- 1% dimming capability with Dim to Off
- Programming via Inventronics PC programmer / Tuner4TRONIC
- Very low ripple for high lighting quality
- 12V Aux included
- Long lasting and high reliability
- UL Class 2

#### Applications

Linear and area lighting  
Office – industrial – shop – retail

#### Approbations & Certifications

**FCC / cULus / Class P**

In preparation, if not already printed on the label



**CLASS P**

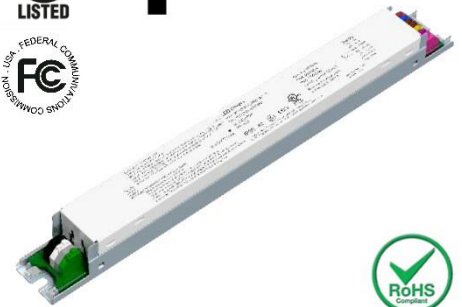

Size	Unit	Inch	Millimeter
Case Length		11.02	280.00
Case Width		1.14	29.00
Case Height		1.02	26.00
Mounting Length		10.63	270.00
Connectors		UL, KF250-3.5, 250-402 Push Pin or equivalent	

### Product Features

- 1% dimming capability incl. Dim to Off
- 0-10V / PWM dimming
- Low THD  $\leq 20\%$  @ full load
- Input voltage: 120 – 277V
- Very wide ambient temperature range
- Programmable drivers
- Low flicker index  $< 5\%$
- 12Vaux included
- Long lifetime up to 100k hours
- 5 years warranty

	Item	Value	Unit	Remarks	
INPUT	Nominal voltage	120 – 277	V		
	Nominal frequency	50 / 60	Hz	Max 47 – 63Hz	
	AC voltage range	108 – 305	V		
	Input current AC	0.58/0.23	mA	120, 277V	
	Total Harmonic Distortion (THD)	≤ 20	%	120Vac / 270Vac output ≥ 60% load	
	Stand-by power	3.5 max	W	50W Dim to Off	
	Power factor	≥ 0.9		120Vac / 270Vac output ≥ 60% load	
	Efficiency	Up to 86	%	Full load	
	Leakage current	300 / 750	μA	120Vac/277 Vac / 60Hz Input, Output Full Load	
OUTPUT	Inrush current max	3.6A / 16.5A	A	120Vac / 277Vac Typical / $t_{width} = 40 \mu s$ typical (max)	
	Nominal voltage range	10 - 56	Vdc	59V max	
	Maximum voltage	59	Vdc	120V-277Vac / 60Hz Input	
	Nominal current range	400 – 1400	mA		
	Current accuracy	+/- 5	%	at 120-277Vac nominal voltage	
	Flicker index	< 5	%	Full load	
	Max. power	50	W		
	Start-Up Time	500	ms	120/277Vac / 60Hz Input, Output Full load	
	DIMMING	Dimming technology	0...10V / PWM		Linear & log dimming curve / PWM frequency: 200Hz – 2kHz
12V auxiliary output		10.8 / 12.0 / 13.2	V	Min./Typ./Max. – yellow wire	
12V auxiliary current		200	mA		
0-10V dimming		0 / 10 / 15	V	Min./Typ./Max. – purple wire	
Output source current		200	μA	Max. – purple Wire	
ENVIRONMENT	Dimming range	1-100%	%	1% dimming capability	
	Ambient temperature range $t_a$	-40 ... +50	°C	50W	
	Maximum case temperature $t_c$	90	°C		
	Storage temperature range	-40 ... +85	°C		
	Relative humidity	5 ... 85	%	Not condensing	
	Surge transient protection	2   4	kV	L-N; L-FG & N-FG	
	Environmental rating	Indoor			
	IP rating	IP 20			
	Expected lifetime	50'000		h	$t_c = 80^\circ C$
		100'000			$t_c = 70^\circ C$

## Wiring diagram

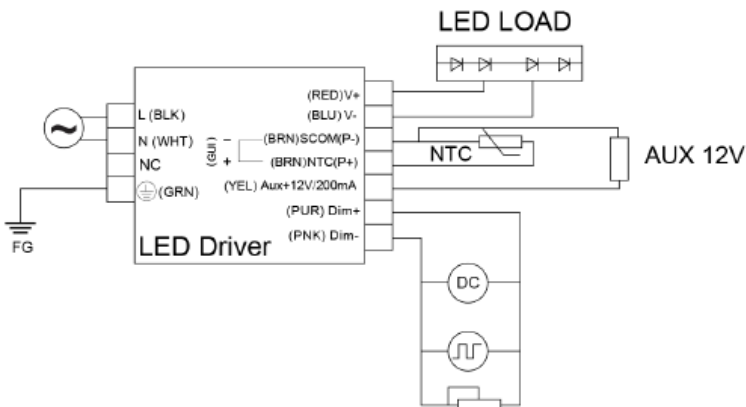

## Installation / wiring

Wire preparation:  
0.5-1.5mm<sup>2</sup>

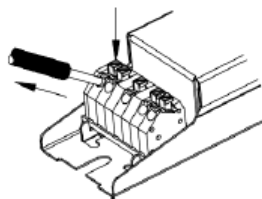
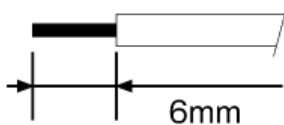

Only Solid wire with a cross section of 0.5 – 1.5 mm<sup>2</sup>.

Strip 6mm of insulation from the cables to ensure perfect operation of terminals

## Operating window

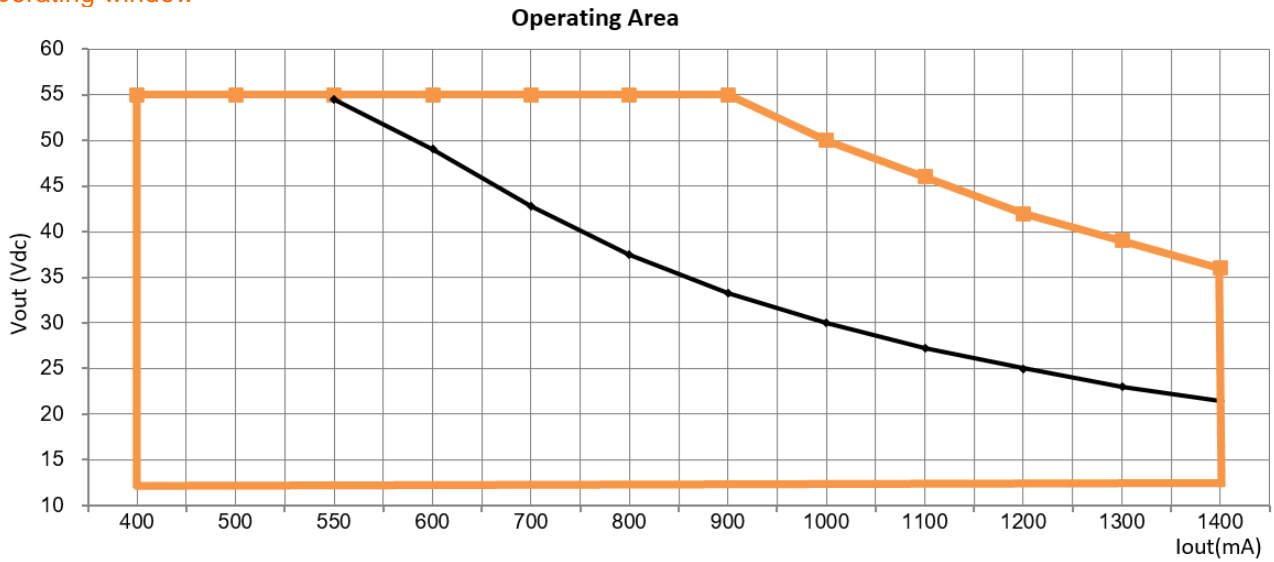

## Efficiency vs power

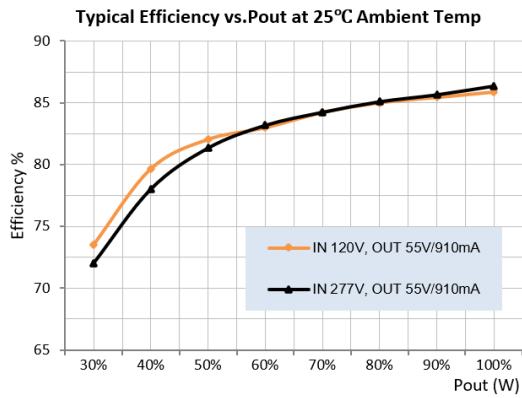

## PF vs power

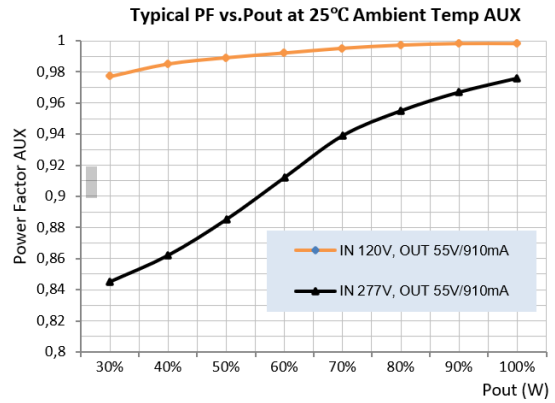

## THD vs power

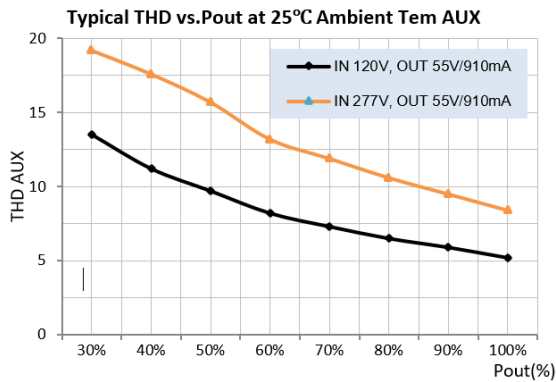

Overtemperature protection behavior

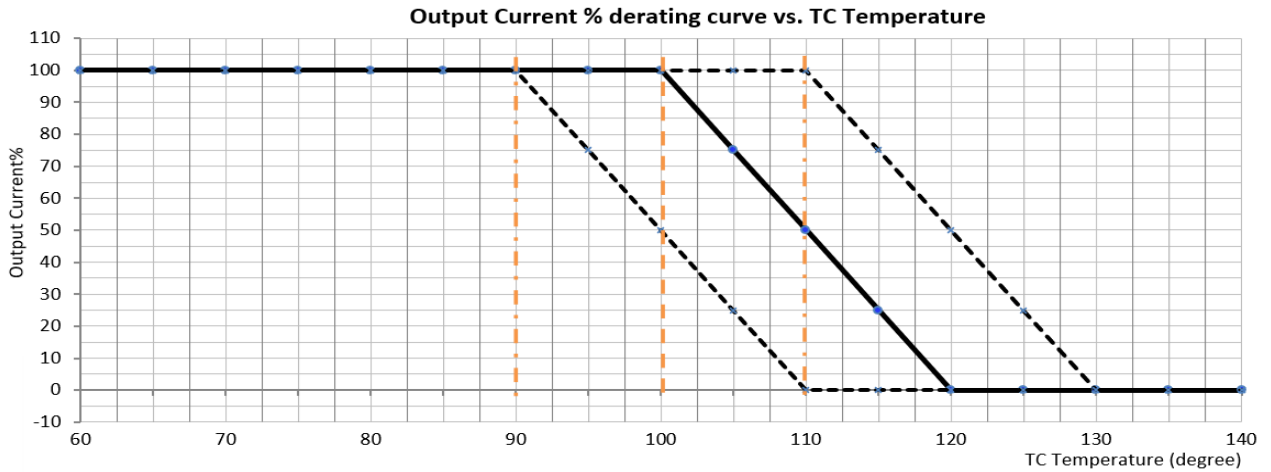

0-10V dimming curve @ minimum dimming set to 1%

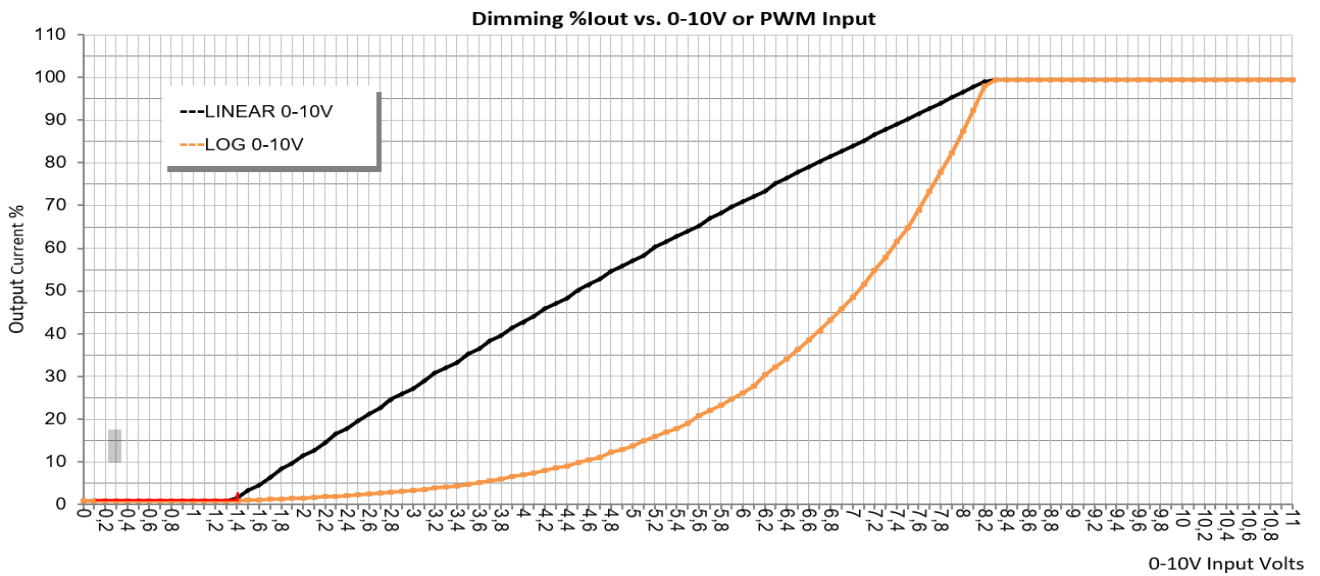

1-10V Dimming curve @ minimum dimming set to 1%

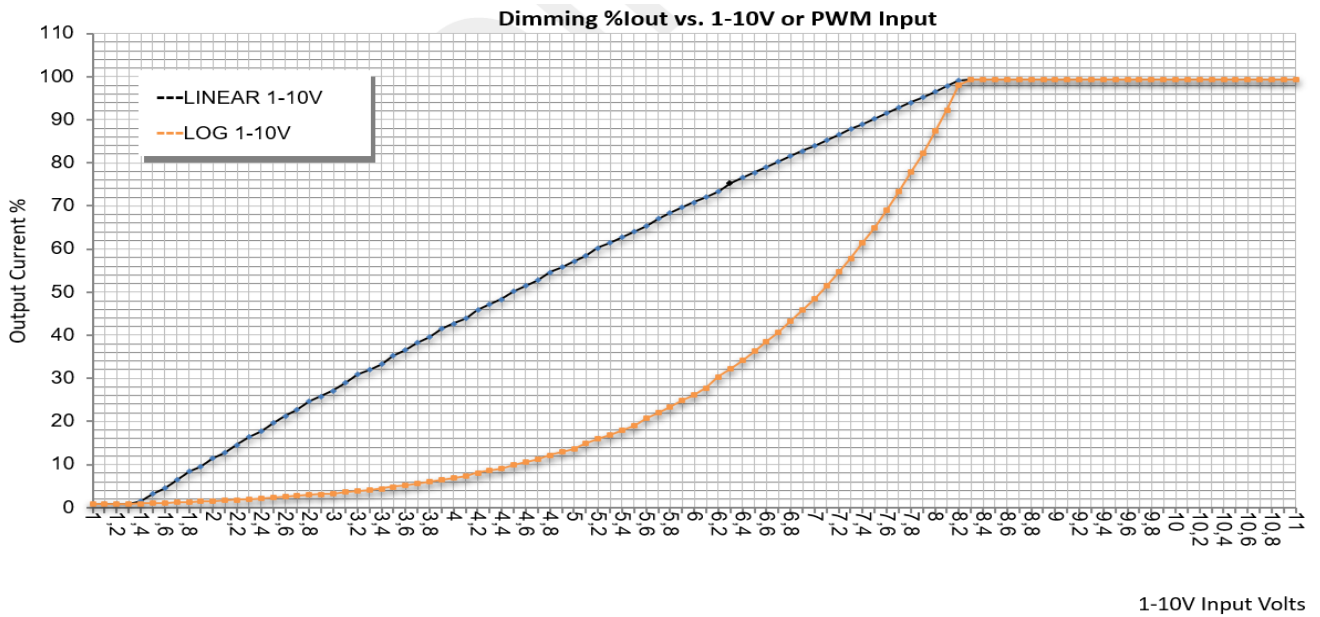

## Programming & current setting

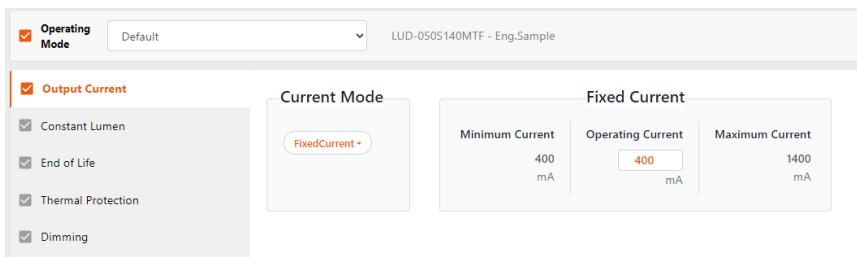

Please use the Inventronics Programmer (Hardware) and Tuner4TRONIC (Software) to program current / features.  
 For further information please refer to [www.tuner4tronic.com](http://www.tuner4tronic.com)

## Protections

- Output short circuit
- Output over current
- Over temperature protection
- Output over voltage

## Programmable features

- Output current
- NTC
- Soft start
- Dim to off
- End-of-life indicator
- Dimming curve
- Constant lumen

## Safety / EMC compliance

- UL / cUL                      UL8750, CSA-C22.2, Class 2, UL Class P
- FCC                              FCC Part 15 Subpart B, Class A
- Ring Wave                    NEMA SSL1

## Ordering information

Part Number	Ordering Code / EAN (single)	Ordering Code / EAN (package)	Pieces / Package
LUD-050S140MTF	6977078992398	6977078992404	40

Inventronics  
 2825 S. Tulsa Avenue  
 Oklahoma City OK 73108  
 United States  
[www.inventronicsglobal.com](http://www.inventronicsglobal.com)

