

Features

- Non-Isolated Class I Driver
- No Afterglow
- Dimming Range: 0.1%-100%
- 2*750W Independent Programmable Channels
- Max Remote Distance Up to 300 Meters (Dimming and Output)
- Ultra High Efficiency (Up to 97%)
- Full Power at Wide Output Current Range (Constant Power)
- Adjustable Output Current (AOC) with NFC
- DALI-2 and D4i Certified & DMX-RDM & 3-Timer-Modes Dimmable
- Single-channel (1*DT6 or 1*DMX) Operating Mode
- Multi-channel (2*DT6 or 2*DMX) Operating Mode
- DALI-2/DMX-RDM Controls Up to 44 fps
- Integrated Power Metering with High Accuracy up to $\pm 1\%$
- Thermal Sensing and Protection for LED Module
- Low Inrush Current
- Output Lumen Compensation
- End-of-Life Indicator
- Input Surge Protection: DM 10kV, CM 10kV
- All-Around Protection: IOVP, IUVP, OVP, SCP, OTP, OPP
- IP66
- IK08 Enclosure
- 5 Years Warranty

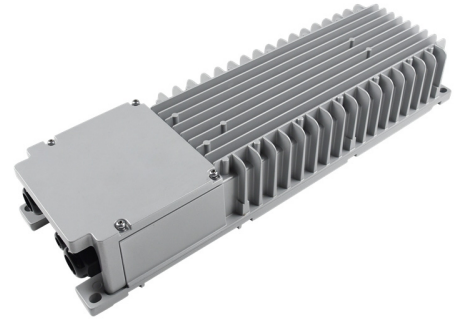

Description

The NSS-1K5DxxxBC series is a 1500W, 2 channels, constant-current, programmable and IP66 LED driver that operates from 249-528 Vac input with excellent power factor. Created for many lighting applications including sports, high mast, UV-LED, aquaculture and horticulture, etc. The dimming control supports two-way communication via DALI-2 and complies with D4i, furthermore it incorporates DMX-RDM dimming. The high efficiency of these drivers and compact metal case enables them to run cooler, significantly improving reliability and extending product life. To ensure trouble-free operation, protection is provided against input surge, input under voltage, input over voltage, output over voltage, short circuit, and over temperature.

Models

Adjustable Output Current Range (mA)	Full-Power Current Range (mA) ⁽¹⁾	Default Output Current (mA)	Output Voltage Range (Vdc)	Max. Output Power (W)	Typical Efficiency ⁽²⁾	Typical Power Factor		Model Number ⁽³⁾
						277Vac	480Vac	
1.5-2100	1500-2100	1500	176-500	1500	97.0%	0.99	0.95	NSS-1K5D210BC

- Notes:** (1) Output current range with constant power at 750W per channel.
 (2) Measured at 100% load and 480Vac input (see below "General Specifications" for details).
 (3) Certified voltage range: 277-480Vac

I-V Operation Area

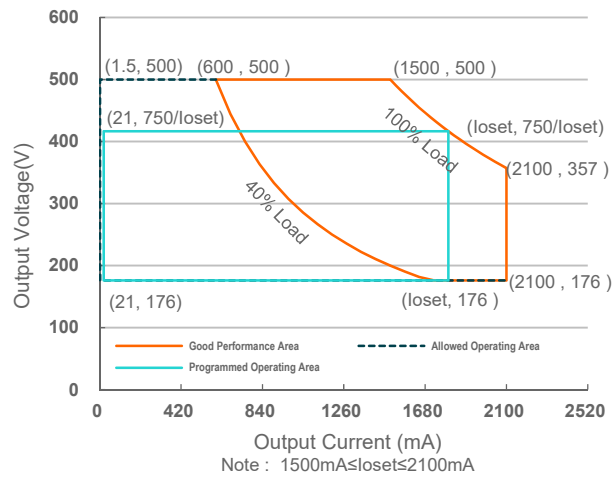

Driver Function Diagram

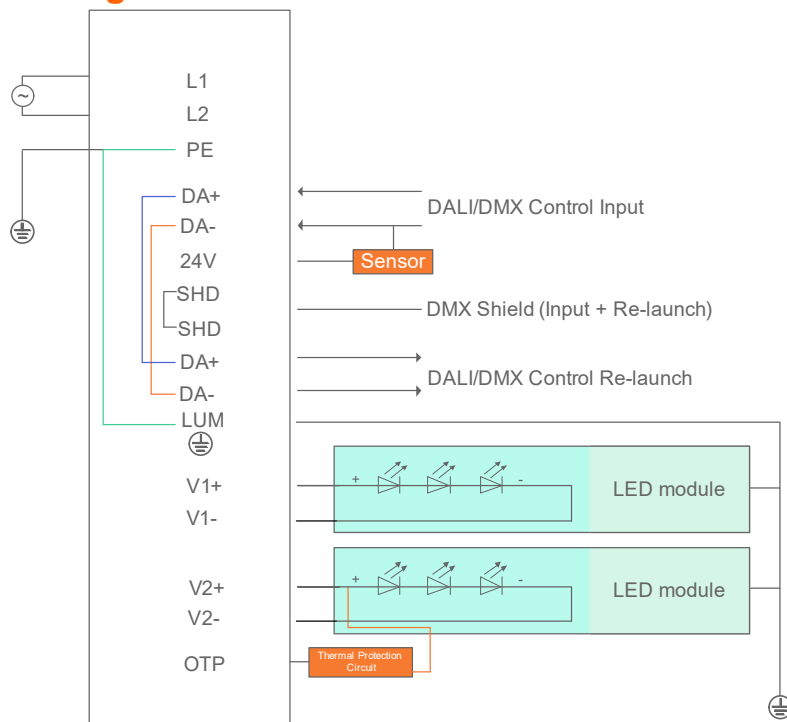

Input Specifications

Parameter	Min.	Typ.	Max.	Notes
Input AC Voltage	249 Vac	-	528 Vac	
Input DC Voltage	352 Vdc	-	500 Vdc	
Input Frequency	47 Hz	-	63 Hz	

Input Specifications (Continued)

Parameter	Min.	Typ.	Max.	Notes
Leakage Current	-	-	0.75 MIU	UL 8750; 480Vac/ 60Hz
			0.70 mA	IEC 60598-1; 480Vac/ 60Hz, grounding effectively
Input AC Current	-	-	6.09 A	Measured at 100% load and 277 Vac input.
	-	-	3.67 A	Measured at 100% load and 480 Vac input.
Inrush Current(I ² t)	-	-	4.08 A ² s	At 480Vac input, 25°C cold start, duration=20.0 ms, 10%Ipk-10%Ipk.
PF	0.90	-	-	At 277-480Vac, 50-60Hz, 40%-100% Load (600 - 1500W)
THD	-	-	20%	

Output Specifications

Parameter	Min.	Typ.	Max.	Notes
Output Current Tolerance	-5%loset	-	5%loset	100% load
Output Current Setting(loset) Range				
NSS-1K5D210BC	21 mA	-	2100 mA	
Output Current Setting Range with Constant Power				
NSS-1K5D210BC	1500 mA	-	2100 mA	
Total Output Current Ripple (pk-pk)	-	2%Iomax	5%Iomax	100% load, 20 MHz BW
Output Current Ripple at < 3000 Hz (pk-pk)	-	1%Iomax	-	At 70-100% load condition. Only this component of ripple is associated with visible flicker.
Startup Overshoot Current	-	-	10%Iomax	100% load
No Load Output Voltage	-	-	600 V	
Line Regulation	-	-	±2.5%	100% load
Load Regulation	-	-	±5.0%	
Turn-on Delay Time	-	-	0.5 s	Measured at DMX-RDM/Time dimming mode, and 277-480Vac input, 40%-100% Load
	-	-	1.0 s	Measured at DALI-2 dimming mode, and 277-480Vac input, 40%-100% Load
Temperature Coefficient of loset	-	0.03%/°C	-	Case temperature = 0°C ~Tc max

Output Specifications (DALI Dimming Mode)

Parameter	Min.	Typ.	Max.	Notes
24V Auxiliary Output Voltage	21.6 V	24 V	26.4 V	$P_{load} \geq 0.1W$
	-	-	30 V	$P_{load} < 0.1W$
24V Auxiliary Output Voltage ripple (pk-pk)	-	-	1.0 V	$P_{load} \geq 0.1W, f_{ripple} > 10kHz$
24V Auxiliary Output Source Current	0 mA	-	125 mA	Return terminal is "DA-"
24V Auxiliary Output Transient Peak Current@6W	-	-	250 mA	250mA peak for a maximum duration of 2.2ms in a 6.0ms period during which time the average should not exceed 125mA.
24V Auxiliary Output Transient Peak Current@10W	-	-	425 mA	425mA peak for a maximum duration of 1.3ms in a 5.2ms period during which time the average should not exceed 125mA.
Integrated DALI-2 Bus Power Supply Voltage	12 Vdc	16 Vdc	20 Vdc	Voltage is depending on loading.
Integrated DALI-2 Bus Power Maximum Supply Current	60 mA			
Integrated DALI-2 Bus Power Guaranteed Supply Current	50 mA			DALI-2 Bus Power Supply Voltage $\geq 12V$

Notes: (1) When driver works in DMX-RDM mode, 24V auxiliary cannot be loaded and cannot be connected to the system.
 (2) DALI-2 bus power supply is enabled by default and can be disabled via programming interface.
 (3) DALI-2 bus power supply supports automatic shut-down and restart after short-circuit.

General Specifications

Parameter	Min.	Typ.	Max.	Notes
Efficiency at 277 Vac input: $I_o = 1500\text{ mA}$ $I_o = 2100\text{ mA}$	94.5% 94.0%	96.5% 96.0%	- -	Measured at 100% load and steady-state temperature in 25°C ambient; (Efficiency will be about 2.0% lower if measured immediately after startup.)
Efficiency at 400 Vac input: $I_o = 1500\text{ mA}$ $I_o = 2100\text{ mA}$	95.0% 95.0%	97.0% 97.0%	- -	Measured at 100% load and steady-state temperature in 25°C ambient; (Efficiency will be about 2.0% lower if measured immediately after startup.)
Efficiency at 480 Vac input: $I_o = 1500\text{ mA}$ $I_o = 2100\text{ mA}$	95.0% 95.0%	97.0% 97.0%	- -	Measured at 100% load and steady-state temperature in 25°C ambient; (Efficiency will be about 2.0% lower if measured immediately after startup.)
Power Monitoring Accuracy	-1%	-	1%	Measured at 480Vac input and 100%Load
Standby Power	-	1.5W		Measured at 480Vac/50Hz; Dimming off when Bus Power Supply is disabled
MTBF	-	261,000 Hours	-	Measured at 480Vac input, 80%Load and 25°C ambient temperature (MIL-HDBK-217F)
Lifetime	-	100,000 Hours	-	Measured at 480Vac input, 80%Load and 70°C case temperature; See lifetime vs. Tc curve for the details

General Specifications (Continued)

Parameter	Min.	Typ.	Max.	Notes
Operating Case Temperature for Safety T _{c_s}	-40°C	-	+90°C	
Operating Case Temperature for Warranty T _{c_w}	-40°C	-	+80°C	Case temperature for 5 years warranty Humidity: 10%RH to 95%RH
Storage Temperature	-40°C	-	+85°C	Humidity: 5%RH to 95%RH
Dimensions Inches (L × W × H) Millimeters (L × W × H)	19.69 × 5.98 × 3.15 500 × 152 × 80			
Net Weight	-	5020 g	-	

Dimming Specifications

Parameter	Min.	Typ.	Max.	Notes	
DALI Dimming Mode (Default)	DA+, DA- High Level	9.5 V	16 V	22.5 V	
	DA+, DA- Low Level	-6.5 V	0 V	6.5 V	
	DA+, DA- Current	0 mA	-	2 mA	
	Dimming Output Range	0.1%loset	-	loset	1500 mA ≤ loiset ≤ 2100 mA
1.5 mA		-	loset	21 mA ≤ loiset < 1500 mA	
DMX-RDM Dimming Mode	DMX+ to DMX-	-6 V	-	6 V	
	DMX+ to Chassis	22M ohm	-	-	
	DMX- to Chassis	22M ohm	-	-	
	Logic 0 Input	-	-	-0.2 V	DMX+ to DMX-
	Logic 1 Input	0.2 V	-	-	DMX+ to DMX-
	Communication Baud Rate	-	250k bps	-	
	Dimming Output Range	0.1%loset	-	loset	1500 mA ≤ loiset ≤ 2100 mA
1.5 mA		-	loset	21 mA ≤ loiset < 1500 mA	

Safety & EMC Compliance (Continued)

Safety Category	Standard
UL/CUL	UL 8750, CAN/CSA-C22.2 No. 250.13
ENEC	EN 61347-1, EN 61347-2-13
CE	EN 61347-1, EN 61347-2-13 EN 301 489-1 EN 301 489-3 EN 300 330 EN 62479/EN 50663/EN 50665/EN 50364

Safety & EMC Compliance

Safety Category	Standard
CB	IEC 61347-1, IEC 61347-2-13
CCC	GB 19510.1, GB 19510.14
global-mark	AS/NZS 61347.1, AS/NZS 61347.2.13
Performance	Standard
ENEC	EN IEC 62384
EMI Standards	Notes
EN IEC 55015/GB/T 17743 ⁽¹⁾	Conducted emission Test & Radiated emission Test
EN IEC 61000-3-2/GB 17625.1	Harmonic current emissions
EN 61000-3-3	Voltage fluctuations & flicker
FCC Part 15 ⁽¹⁾	ANSI C63.4 Class B
	This device complies with Part 15 of the FCC Rules. Operation is subject to the following two conditions: [1] this device may not cause harmful interference, and [2] this device must accept any interference received, including interference that may cause undesired Operation.
EMS Standards	Notes
EN 61000-4-2	Electrostatic Discharge (ESD): 8 kV air discharge, 4 kV contact discharge
EN 61000-4-3	Radio-Frequency Electromagnetic Field Susceptibility Test-RS
EN 61000-4-4	Electrical Fast Transient / Burst-EFT
EN 61000-4-5	AC mains Surge Immunity Test: AC Power Line: Differential Mode 10 kV, Common Mode 10 kV
	Output - Common Mode: 3kV V1+/V2+ to PE V1-/V2- to PE - Differential Mode: 1kV (V1+ to V1-, V2+ to V2-)
	Dimming - Common Mode: 3kV DA+/DA- to PE - Differential Mode: 1kV DA+ to DA-
	OTP - Common Mode: 3kV OTP to PE - Differential Mode: 1kV OTP to V1+/V2+
EN 61000-4-6	Conducted Radio Frequency Disturbances Test-CS
EN 61000-4-8	Power Frequency Magnetic Field Test
EN 61000-4-11	Voltage Dips
EN 61547	Electromagnetic Immunity Requirements Applies To Lighting Equipment
DALI-2 Standards	Notes
DALI-2 ⁽²⁾	IEC 62386-101, -102 & -207

Note: (1) This LED driver meets the EMI specifications above, but EMI performance of a luminaire that contains it depends also on the other devices connected to the driver and on the fixture itself.

(2) DALI Parts: 101, 102, 150, 207, 250, 251, 252, 253.

● Isolation levels between different circuits:

	AC Input	DC Output	Dimming (SELV)	Housing
AC Input	/	No isolation	Double	Basic
DC Output	No isolation	/	Double	Basic
Dimming (SELV)	Double	Double	/	Basic
Housing	Basic	Basic	Basic	/

Lifetime vs. Case Temperature

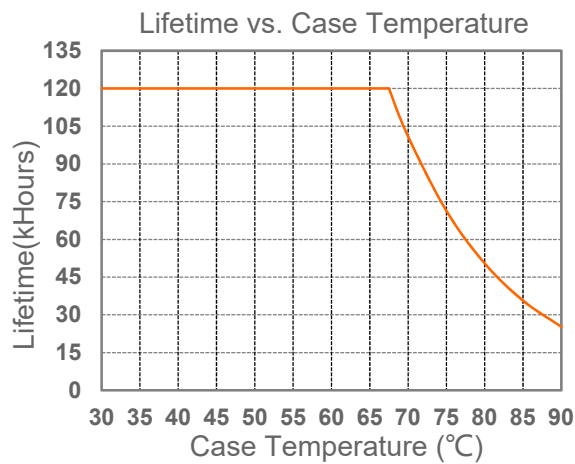

Inrush Current Waveform

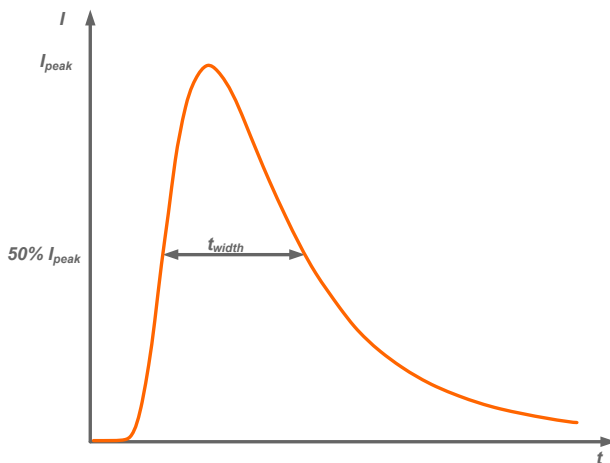

Input AC Voltage	I_{peak}	t_{width} (@ 50% I_{peak})
277Vac	11.1 A	5.40 ms
400Vac	13.7 A	6.40 ms
480Vac	16.5 A	6.20 ms

MCB	Tripping Curves	B	B	B	B	C	C	C	C
	Rated Current	10A	16A	20A	25A	10A	16A	20A	25A
The Number of LED Driver can be Configured	277Vac	1	1	2	2	1	1	2	3
	400Vac	0	1+1+1	1+1+1	2+2+2	1+1+1	1+1+1	2+2+2	2+2+2
	480Vac	1+1+1	1+1+1	2+2+2	2+2+2	1+1+1	1+1+1	2+2+2	3+3+3

Efficiency vs. Load

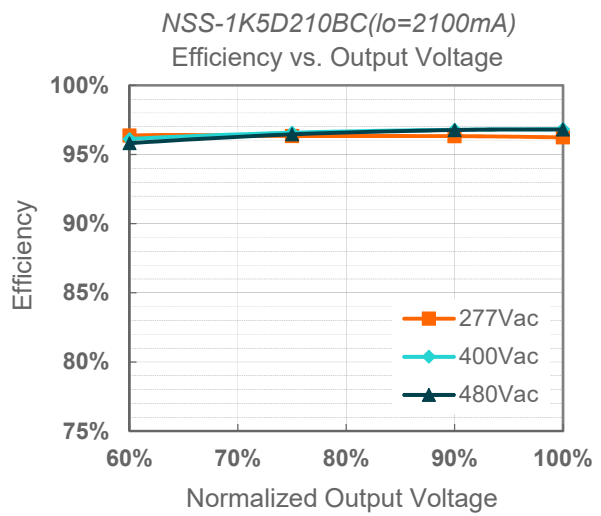
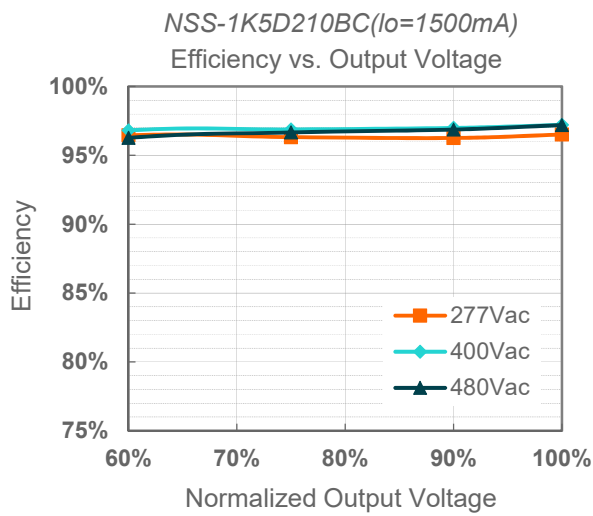

Power Factor

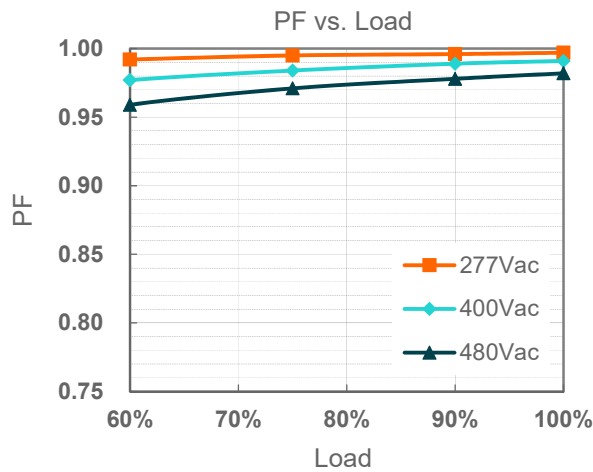

Total Harmonic Distortion

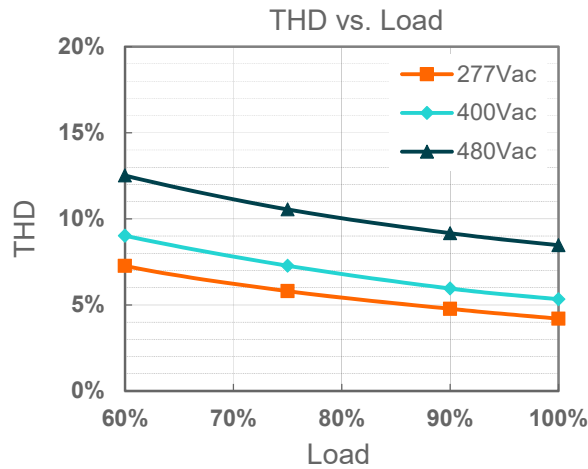

Protection Functions

Parameter		Min.	Typ.	Max.	Notes
Over Temperature Protection		Decreases output current smoothly, returning to normal after over temperature is removed.			
Short Circuit Protection		Auto Recovery. No damage will occur when any output is short circuited. The output shall return to normal when the fault condition is removed.			
Over Power Protection		Each channel exceeds 787W (typical), the driver will decrease this channel output current automatically.			
Over Voltage Protection		Limits output voltage at no load and in case the normal voltage limit fails.			
Input Under Voltage Protection (IUVP)	Input Under Voltage Protection	220 Vac	230 Vac	240 Vac	Turn off the output when the input voltage falls below protection voltage.
	Input Under Voltage Recovery	230 Vac	240 Vac	250 Vac	Auto Recovery. The driver will restart when the input voltage exceeds recovery voltage.
Input Over Voltage Protection (IOVP)	Input Over Voltage Protection	550 Vac	570 Vac	590 Vac	Turn off the output when the input voltage exceeds protection voltage.
	Input Over Voltage Recovery	530 Vac	550 Vac	570 Vac	Auto Recovery. The driver will restart when the input voltage falls below recovery voltage.
	Max. of Input Over Voltage	-	-	590 Vac	The driver can survive for 8 hours with a stable input voltage stress of 590Vac

● Input Under Voltage Protection Diagram

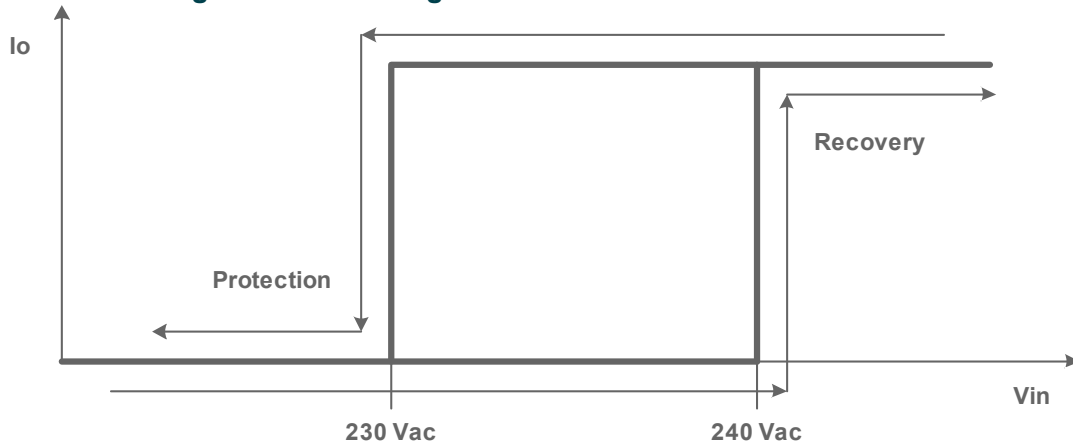

● Input Over Voltage Protection Diagram

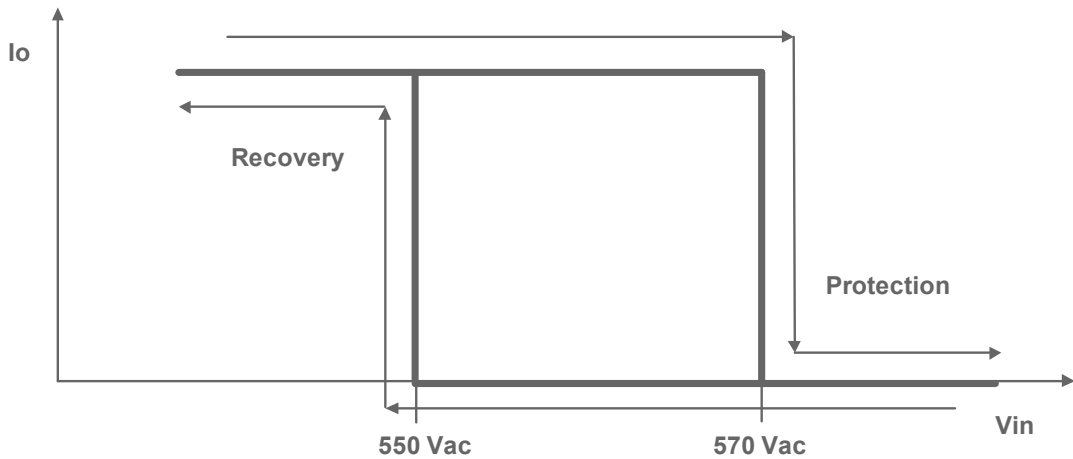

● External Thermal Protection

This needs an external circuit which locates on the hottest part of LEDs to protect the whole luminaire when the temperature exceeds the ratings. The circuit will be connected by V+ LED and OTP terminal on driver. The default protection temperature point is 90°C, it can be changed by Inventronics programmer along with the actual target.

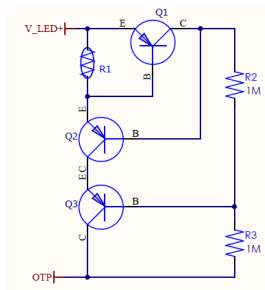

Reference	Description	Recommendation
Q1/Q2/Q3	500V PNP high-voltage transistor	NEXPERIA / PBHV9050T
R1	NTC 10KΩ	0603 SMD 3% EPCOS / TDK B57371V2103H060 B25-100=4480
R2/R3	1MΩ Resistor	1M 1% -55~155°C 0805/1206 200V

● Strobe function

This driver supports strobe function up to 44 fps from 100% dimming to 0% change forth and back. In order to protect relays reliability, the relays will still keep 3s 'ON' status when receiving the dim-to-off command and then enter "OFF" status without receiving dimming ON command, but it will immediately operates back to "ON" status if receiving the dimming on command, so the relays will not operate 'ON' and 'OFF' frequently in fast strobe operation within 3s duration time in default mode. The default 3s can be adjusted by programming interface or commands.

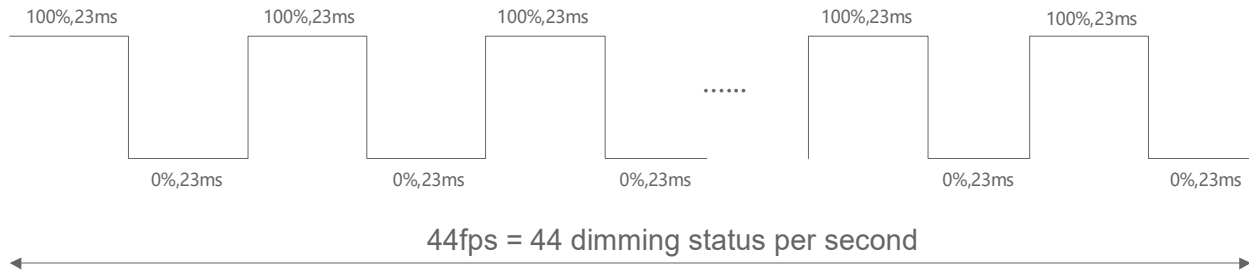

Dimming (DALI Dimming Mode)

● DALI-2 Dimming

The recommended implementation of the dimming control is provided below.

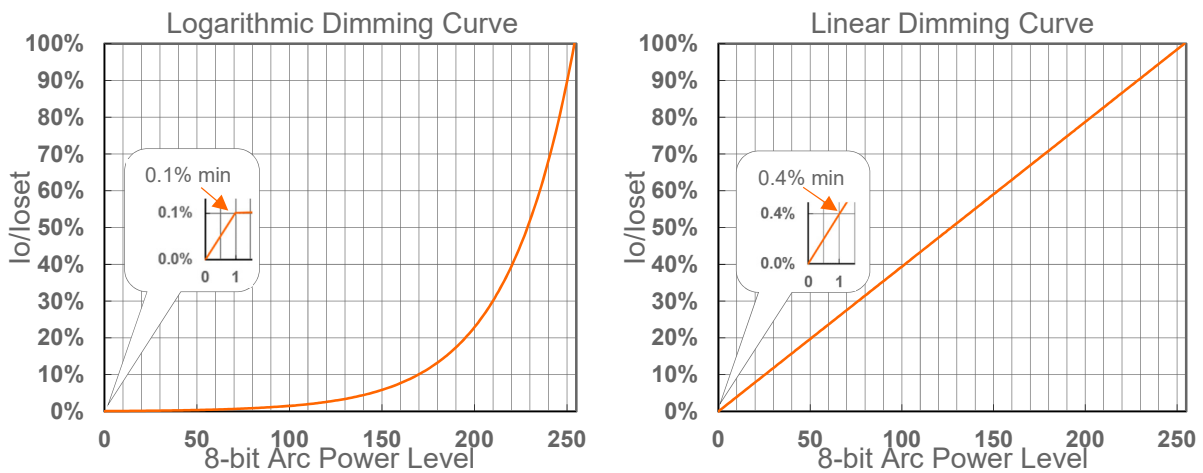

Implementation: DALI-2 Dimming

Dimming (DMX-RDM Dimming Mode)

DMX-RDM Dimming

The recommended implementation of the dimming control is provided below.

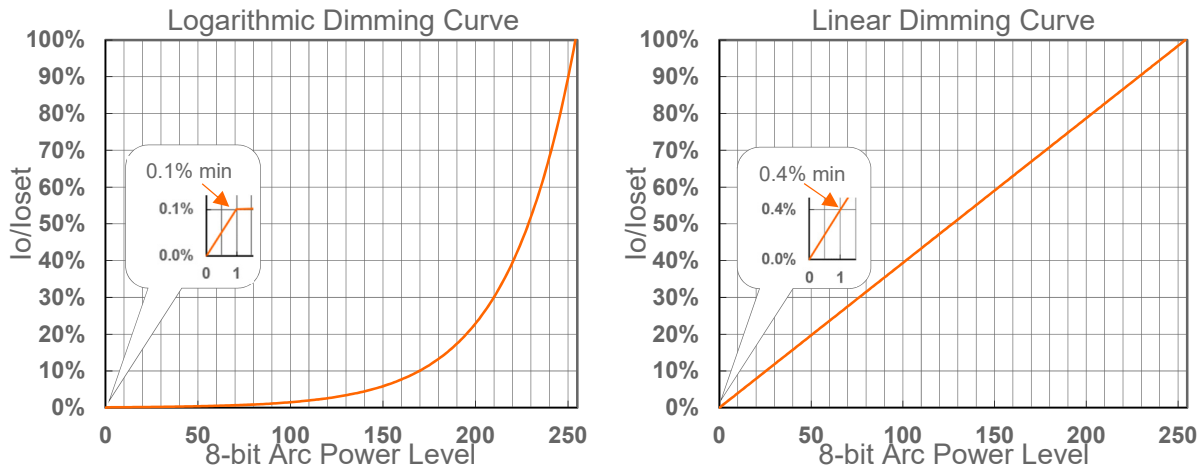

Implementation: DMX-RDM Dimming

Note:

1. The compatible on control system list please refer to: [DMX-RDM Dimming Compatible Control System List](#).
2. Up to 32 drivers may be daisy-chained, terminated by a 120 ohms resistor (connected between DMX+ & DMX- at the last driver)
3. 300m maximum length between driver and master
4. 100m maximum between drivers
5. For best performance, a characteristic impedance of 120 ohms should be maintained for the entire length of the control line.

Time Dimming

Time dimming control includes 3 kinds of modes, they are Self Adapting-Midnight, Self Adapting-Percentage and Traditional Timer.

- **Self Adapting-Midnight:** Automatically adjusts the dimming curve based on the on-time of past two days (if difference <15 minutes), assuming that the center point of the dimming curve is midnight local time.
- **Self Adapting-Percentage:** Automatically adjusts the on-time of each step by a constant percentage = (actual on-time for the past 2 days if difference <15 min) / (programmed on-time from the dimming curve).
- **Traditional Timer:** Follows the programmed timing curve after power on with no changes.

Output Lumen Compensation

Output Lumen Compensation (OLC) may be used to maintain constant light output over the life of the LEDs by driving them at a reduced current when new, then gradually increasing the drive current over time to counteract LED lumen degradation.

End Of Life

End-of-Life (EOL) is providing a visual notification to a user that the LED module has reached the end of manufacturer-specified life and that the replacement is recommended. Once active, an indication is given at each power-up of the driver, which the driver indicates this through a lower light output during the first 1 minute before normal operation is continued.

● Cable Gland Diagram

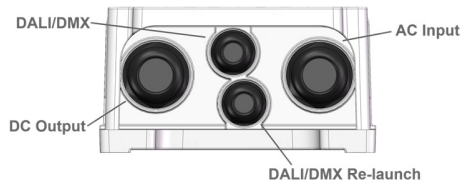

Connection	Cable Gland	Torque (N·m)	Cable Diameter (mm)	Cable AWG	Cable Section (mm ²)	Strip Length (mm)
AC Input	M25	5.5	9.9-14.7	16-14	1.5-2.5	9-10
DC Output	M25	5.5	9.9-14.7	18-14	1.0-2.5	
DALI/DMX	M16	2.5	6.5-10	18-16	0.75-1.5	
DALI/DMX Re-launch	M16	2.5	6.5-10	18-16	0.75-1.5	

● Connection Diagram

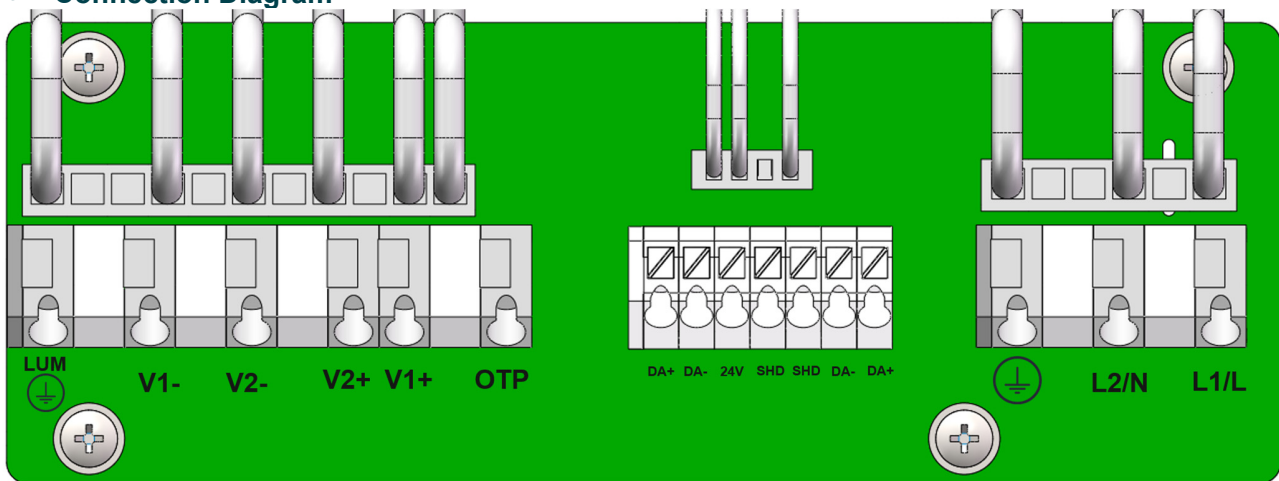

Number	Label	Description
1	LUM ⊕	Protection Earth for LED Module
2	V1-	LED1- Connection
3	V2-	LED2- Connection
4	V2+	LED2+ Connection
5	V1+	LED1+ Connection
6	OTP	Thermal protection input
7	DA+	Reused, DALI/DMX input+
8	DA-	Reused, DALI/DMX input-
9	24V	24V auxiliary source
10	SHD	DMX SHIELD input
11	SHD	DMX SHIELD output
12	DA-	DALI/DMX reused Re-launch output-

Number	Label	Description
13	DA+	DALI/DMX reused Re-launch output+
14	PE	Protection Earth
15	L2/N	AC input L2/N
16	L1/L	AC input L1/L

Note: DALI function and DMX function cannot be used at the same time.

Programming Connection Diagram

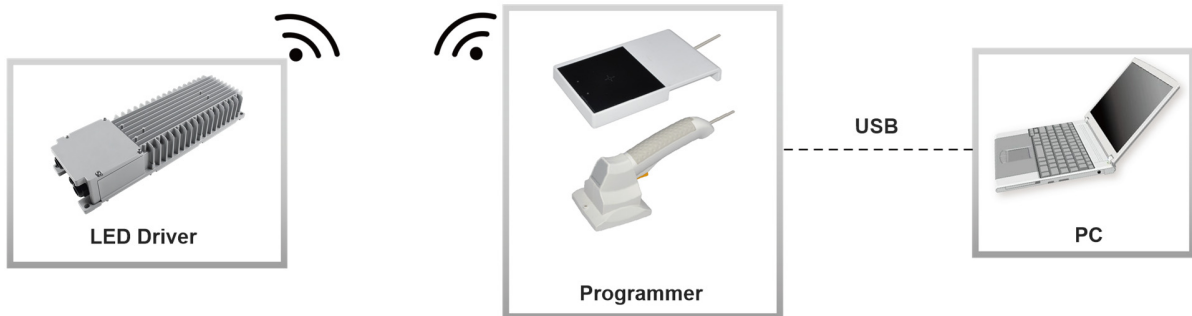

Note: The driver does not need to be powered on during the programming process.

- Please refer to [PRG-NFC-H](#) or [PRG-NFC-D2](#) (Programmer) datasheet for details.

Mechanical Outline

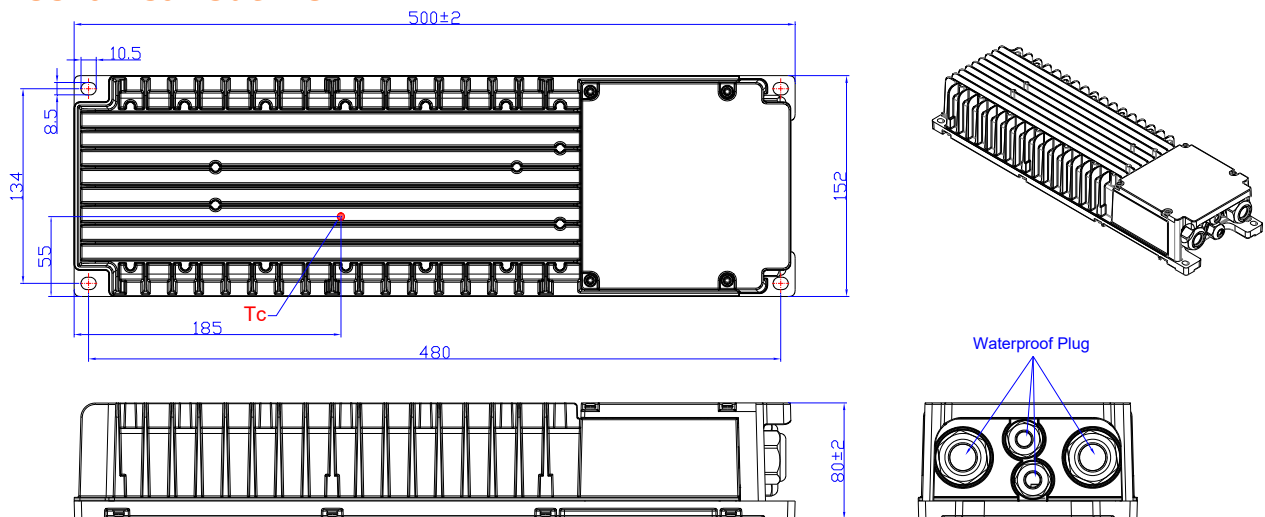

PROJ:

Unspecified tolerance: ± 1

Installations

To download the Installation Guidelines, please click here: [Inventronics Considerations for Non-Isolated LED Drivers](#) and [Installation Guidelines: NFS-1K2-BC/NSS-1K5-BC Driver](#)

RoHS Compliance

Our products comply with reference to RoHS Directive (EU) 2015/863 amending 2011/65/EU, calling for the elimination of lead and other hazardous substances from electronic products.

Revision History

Change Date	Rev.	Description of Change		
		Item	From	To
2024-08-30	A	Datasheet Release	/	/