

Features

- Compact Metal Case with Excellent Thermal Performance
- Full Power at Wide Output Current Range (Constant Power)
- Adjustable Output Current (AOC) with Programmability
- Isolated 1-5V/1-10V/10V PWM/3-Timer-Modes Dimmable
- Output Lumen Compensation
- Input Surge Protection: DM 6kV, CM 10kV
- All-Around Protection: OVP, SCP, OTP
- IP66/IP67 and UL Dry/Damp/Wet Location
- Class 2 & SELV Output
- TYPE HL, for Use in a Class I, Division 2 Hazardous (Classified) Location
- 5 Years Warranty



Description

The EUM-075SxxxDx series is a 75W, constant-current, programmable and IP66/IP67 rated LED driver that operates from 90-305Vac input with excellent power factor. It is created for many lighting applications including high bay, tunnel and roadway lights, etc. The high efficiency of these drivers and compact metal case enables them to run cooler, significantly improving reliability and extending product life. To ensure trouble-free operation, protection is provided against input surge, output over voltage, short circuit, and over temperature.

Models

Adjustable Output Current Range(mA)	Full-Power Current Range(mA) ⁽¹⁾	Default Output Current(mA)	Output Voltage Range(Vdc)	Max. Output Power(W)	Typical Efficiency ⁽²⁾	Typical Power Factor		Model Number ⁽³⁾⁽⁶⁾
						120Vac	220Vac	
30-530	300-530	530	70-250	75	92.0%	0.99	0.96	EUM-075S053Dx ⁽⁷⁾
70-1050	700-1050	700	36-107	75	90.5%	0.99	0.96	EUM-075S105Dx ⁽⁴⁾
105-1500	1050-1500	1050	25-72	75	90.5%	0.99	0.96	EUM-075S150Dx ⁽⁴⁾
140-2100	1400-2100	2100	18-54	75	89.5%	0.99	0.96	EUM-075S210Dx ⁽⁵⁾

- Notes:** (1) Output current range with constant power at 75W
 (2) Measured at 100% load and 220Vac input (see below "General Specifications" for details).
 (3) Certified input voltage range: UL, FCC 100-277Vac; otherwise 100-240Vac.
 (4) SELV Output.
 (5) Class 2 & SELV output.
 (6) x = G are UL Recognized, ENEC and CCC, etc. models; x = T are UL Class P models; x = B are BIS models.
 (7) Only available with x = G, and only with ENEC, CE, CB and CCC certificates.

I-V Operation Area

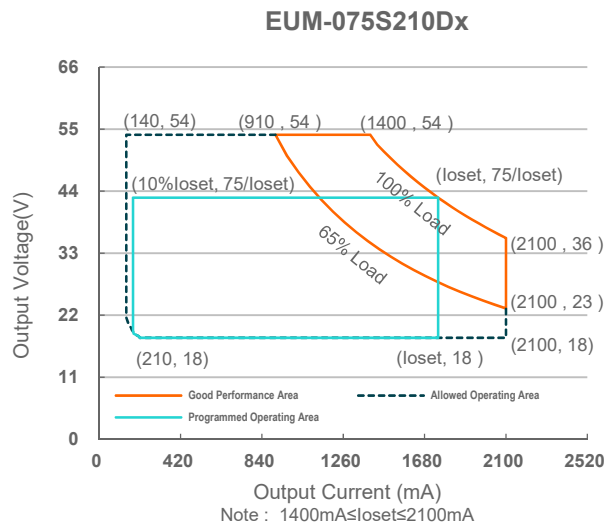
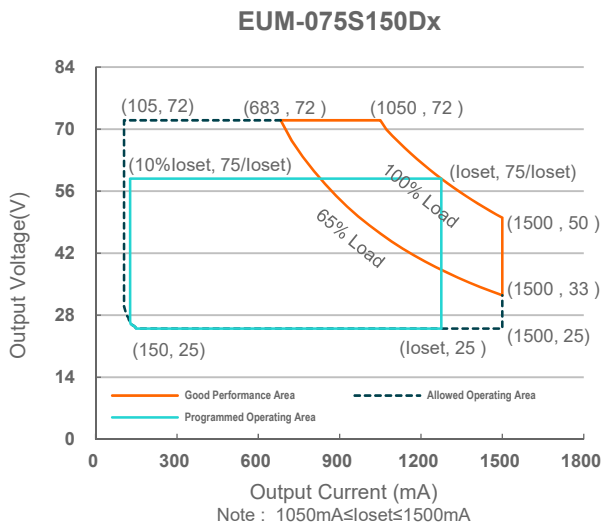
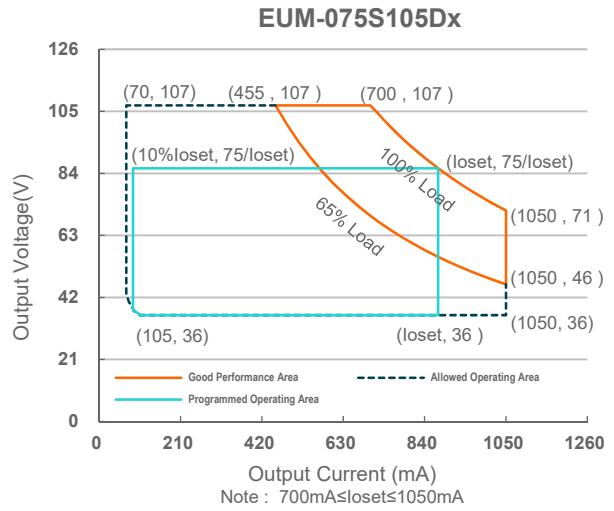
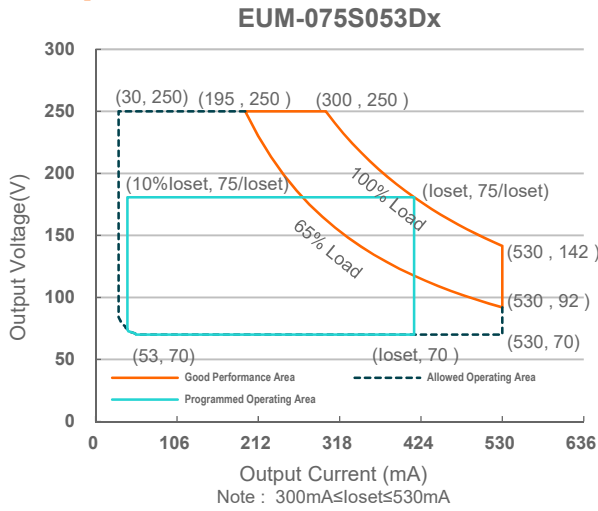

Input Specifications

Parameter	Min.	Typ.	Max.	Notes
Input AC Voltage	90 Vac	-	305 Vac	
Input DC Voltage	127 Vdc	-	300 Vdc	
Input Frequency	47 Hz	-	63 Hz	
Leakage Current	-	-	0.75 MIU	UL 8750; 277Vac/60Hz
	-	-	0.70 mA	IEC 60598-1; 240Vac/60Hz
Input AC Current	-	-	0.79 A	Measured at 100% load and 120 Vac input.
	-	-	0.43 A	Measured at 100% load and 220 Vac input.

Input Specifications (Continued)

Parameter	Min.	Typ.	Max.	Notes
Inrush Current(I ² t)	-	-	0.90 A ² s	At 220Vac input, 25°C cold start, duration=284 μs, 10%I _{pk} -10%I _{pk} .
PF	0.9	-	-	At 100-277Vac, 50-60Hz, 65%-100% Load (49-75W)
THD	-	-	20%	
THD	-	-	10%	At 220-240Vac, 50-60Hz, 75%-100% Load (56-75W)

Output Specifications

Parameter	Min.	Typ.	Max.	Notes
Output Current Tolerance	-5%loset	-	5%loset	At 100% load condition
Output Current Setting(loset) Range				
EUM-075S053Dx	30 mA	-	530 mA	
EUM-075S105Dx	70 mA	-	1050 mA	
EUM-075S150Dx	105 mA	-	1500 mA	
EUM-075S210Dx	140 mA	-	2100 mA	
Output Current Setting Range with Constant Power				
EUM-075S053Dx	300 mA	-	530 mA	
EUM-075S105Dx	700 mA	-	1050 mA	
EUM-075S150Dx	1050 mA	-	1500 mA	
EUM-075S210Dx	1400 mA	-	2100 mA	
Total Output Current Ripple (pk-pk)	-	5%I _{omax}	10%I _{omax}	At 100% load condition. 20 MHz BW
Output Current Ripple at < 200 Hz (pk-pk)	-	2%I _{omax}	-	At 100% load condition. Only this component of ripple is associated with visible flicker.
Startup Overshoot Current	-	-	10%I _{omax}	At 100% load condition
No Load Output Voltage				
EUM-075S053Dx	-	-	330 V	
EUM-075S105Dx	-	-	120 V	
EUM-075S150Dx	-	-	90 V	
EUM-075S210Dx	-	-	60 V	
Line Regulation	-	-	±1%	Measured at 100% load
Load Regulation	-	-	±5%	
Turn-on Delay Time	-	-	0.5 s	Measured at 120-277Vac input, 65%-100% Load
Temperature Coefficient of loset	-	0.06%/°C	-	Case temperature = 0°C ~T _c max

General Specifications

Parameter	Min.	Typ.	Max.	Notes
Efficiency at 120 Vac input:				
EUM-075S053Dx				
Io= 300 mA	86.5%	88.5%	-	
Io= 530 mA	87.5%	89.5%	-	
EUM-075S105Dx				
Io= 700 mA	86.0%	88.0%	-	Measured at 100% load and steady-state temperature in 25°C ambient; (Efficiency will be about 2.0% lower if measured immediately after startup.)
Io=1050 mA	86.5%	88.5%	-	
EUM-075S150Dx				
Io=1050 mA	85.5%	87.5%	-	
Io=1500 mA	86.0%	88.0%	-	
EUM-075S210Dx				
Io=1400 mA	85.0%	87.0%	-	
Io=2100 mA	85.0%	87.0%	-	
Efficiency at 220 Vac input:				
EUM-075S053Dx				
Io= 300 mA	89.0%	91.0%	-	Measured at 100% load and steady-state temperature in 25°C ambient; (Efficiency will be about 2.0% lower if measured immediately after startup.)
Io= 530 mA	90.0%	92.0%	-	
EUM-075S105Dx				
Io= 700 mA	88.5%	90.5%	-	
Io=1050 mA	88.5%	90.5%	-	
EUM-075S150Dx				
Io=1050 mA	88.0%	90.0%	-	
Io=1500 mA	88.5%	90.5%	-	
EUM-075S210Dx				
Io=1400 mA	87.5%	89.5%	-	
Io=2100 mA	87.5%	89.5%	-	
Efficiency at 277 Vac input:				
EUM-075S053Dx				
Io= 300 mA	89.0%	91.0%	-	Measured at 100% load and steady-state temperature in 25°C ambient; (Efficiency will be about 2.0% lower if measured immediately after startup.)
Io= 530 mA	90.0%	92.0%	-	
EUM-075S105Dx				
Io= 700 mA	88.5%	90.5%	-	
Io=1050 mA	89.0%	91.0%	-	
EUM-075S150Dx				
Io=1050 mA	88.5%	90.5%	-	
Io=1500 mA	88.5%	90.5%	-	
EUM-075S210Dx				
Io=1400 mA	87.5%	89.5%	-	
Io=2100 mA	88.0%	90.0%	-	
MTBF	-	521,000 Hours	-	Measured at 220Vac input, 80%Load and 25°C ambient temperature (MIL-HDBK-217F)
Lifetime	-	100,000 Hours	-	Measured at 220Vac input, 80%Load and 70°C case temperature; See lifetime vs. Tc curve for the details
Operating Case Temperature for Safety Tc_s	-40°C	-	+90°C	
Operating Case Temperature for Warranty Tc_w	-40°C	-	+80°C	Case temperature for 5 years warranty Humidity: 10%RH to 95%RH
Storage Temperature	-40°C	-	+85°C	Humidity: 5%RH to 95%RH
Dimensions				With mounting ear
Inches (L × W × H)		4.92 × 2.36 × 1.44		5.59 × 2.36 × 1.44
Millimeters (L × W × H)		125 × 60 × 36.5		142 × 60 × 36.5
Net Weight	-	600 g	-	

Dimming Specifications

Parameter		Min.	Typ.	Max.	Notes
Absolute Maximum Voltage on the Vdim (+) Pin		-20 V	-	20 V	
Source Current on Vdim (+)Pin		200 uA	300 uA	450 uA	Vdim(+) = 0 V
Dimming Output Range	EUM-075S053Dx EUM-075S105Dx EUM-075S150Dx EUM-075S210Dx	10%loset	-	loset	300 mA ≤ loset ≤ 530 mA 700 mA ≤ loset ≤ 1050 mA 1050 mA ≤ loset ≤ 1500 mA 1400 mA ≤ loset ≤ 2100 mA
	EUM-075S053Dx EUM-075S105Dx EUM-075S150Dx EUM-075S210Dx	30 mA 70 mA 105 mA 140 mA	-	loset	30 mA ≤ loset < 300 mA 70 mA ≤ loset < 700 mA 105 mA ≤ loset < 1050 mA 140 mA ≤ loset < 1400 mA
Recommended Dimming Range for 1-5V		0.25 V	-	4.75 V	Dimming mode set to 1-5V in PC interface.
Recommended Dimming Range for 1-10V		1 V	-	9 V	Default 1-10V dimming mode with positive logic.
PWM_in High Level		-	10V	-	
PWM_in Low Level		-	0V	-	
PWM_in Frequency Range		200 Hz	-	2 KHz	
PWM_in Duty Cycle		0%	-	100%	

Safety & EMC Compliance

Safety Category	Standard
UL/CUL	UL 8750,CAN/CSA-C22.2 No. 250.13
ENEC & CE	EN 61347-1, EN 61347-2-13
CB	IEC 61347-1, IEC 61347-2-13
CCC	GB 19510.1, GB 19510.14
PSE	J 61347-1, J 61347-2-13
KS	KS C 7655
BIS	IS 15885(Part2/Sec13)
EAC	TP TC 004, TP TC 020
NOM	NOM-058-SCFI
global-mark	AS/NZS 61347.1, AS/NZS 61347.2.13
Performance	Standard
ENEC	EN IEC 62384
EMI Standards	Notes
EN IEC 55015/GB/T 17743/KS C 9815 ⁽¹⁾	Conducted emission Test &Radiated emission Test

Safety & EMC Compliance (Continued)

EMI Standards	Notes
EN IEC 61000-3-2/GB 17625.1	Harmonic current emissions
EN 61000-3-3	Voltage fluctuations & flicker
FCC Part 15 ⁽¹⁾	ANSI C63.4 Class B
	This device complies with Part 15 of the FCC Rules. Operation is subject to the following two conditions: [1] this device may not cause harmful interference, and [2] this device must accept any interference received, including interference that may cause undesired Operation.
EMS Standards	Notes
EN 61000-4-2	Electrostatic Discharge (ESD): 8 kV air discharge, 4 kV contact discharge
EN 61000-4-3	Radio-Frequency Electromagnetic Field Susceptibility Test-RS
EN 61000-4-4	Electrical Fast Transient / Burst-EFT
EN 61000-4-5	Surge Immunity Test: AC Power Line: Differential Mode 6 kV, Common Mode 10 kV
EN 61000-4-6	Conducted Radio Frequency Disturbances Test-CS
EN 61000-4-8	Power Frequency Magnetic Field Test
EN 61000-4-11	Voltage Dips
EN 61547/KS C 9547	Electromagnetic Immunity Requirements Applies To Lighting Equipment

Note: (1) This LED driver meets the EMI specifications above, but EMI performance of a luminaire that contains it depends also on the other devices connected to the driver and on the fixture itself.

Derating

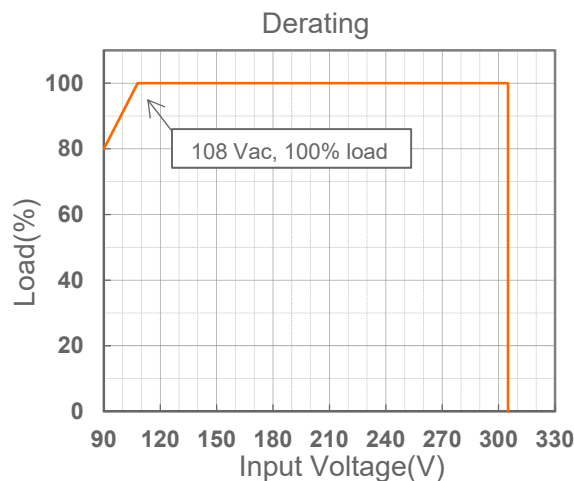

Lifetime vs. Case Temperature

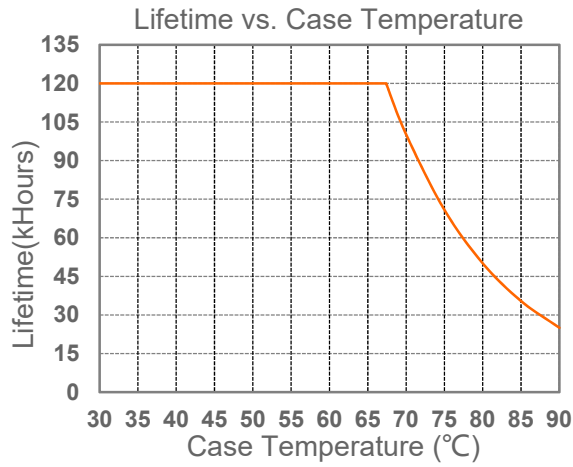

Inrush Current Waveform

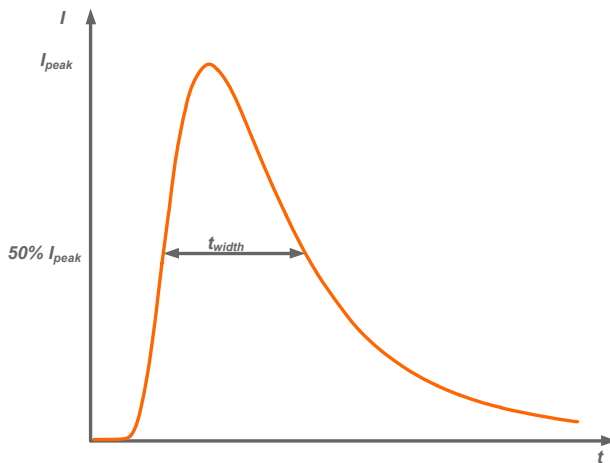

Input AC Voltage	I_{peak}	t_{width} (@ 50% I_{peak})
120Vac	33.8A	164 μ s
220Vac	65.0A	156 μ s
277Vac	80.0A	160 μ s

MCB	Tripping Curves	B	B	B	B	C	C	C	C
	Rated Current	10A	16A	20A	25A	10A	16A	20A	25A
The Number of LED Driver can be Configured	120Vac	8	13	16	21	9	15	19	24
	220Vac	8	14	17	22	14	23	29	36
	277Vac	6	10	13	16	11	18	22	28

Efficiency vs. Load

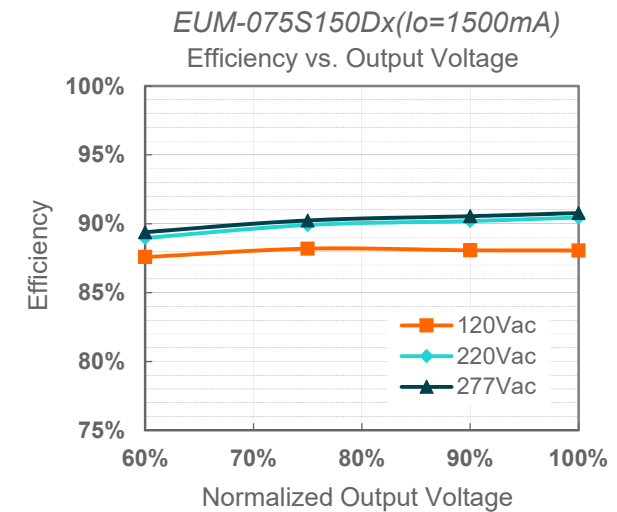
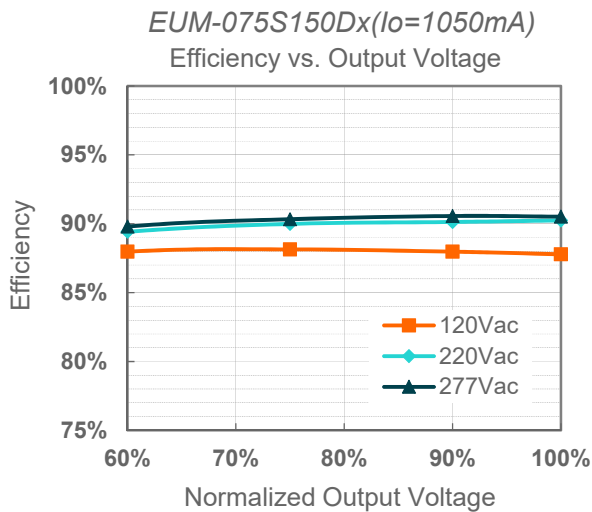
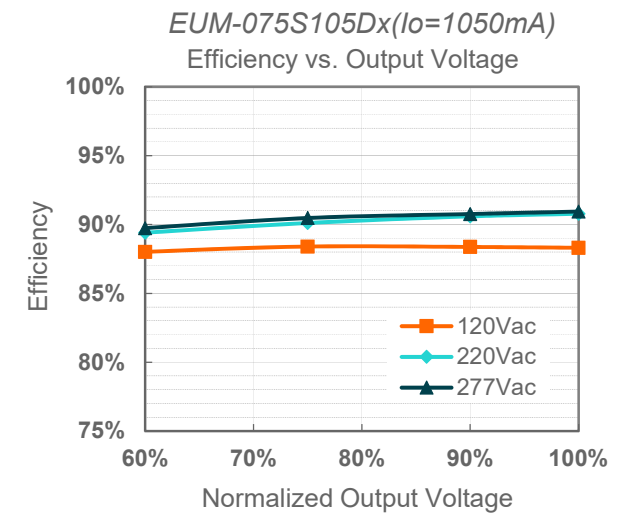
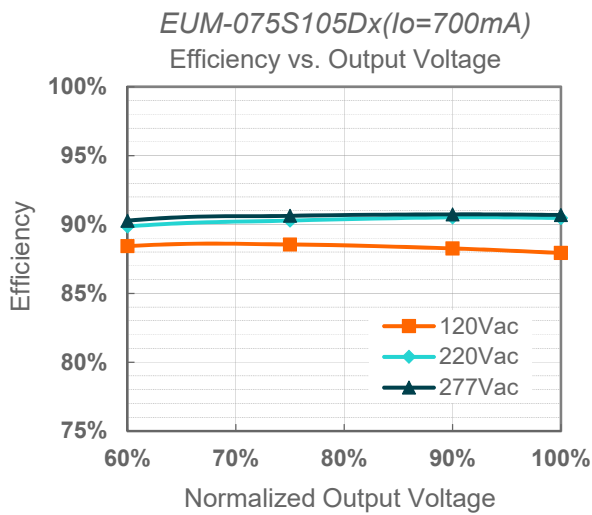
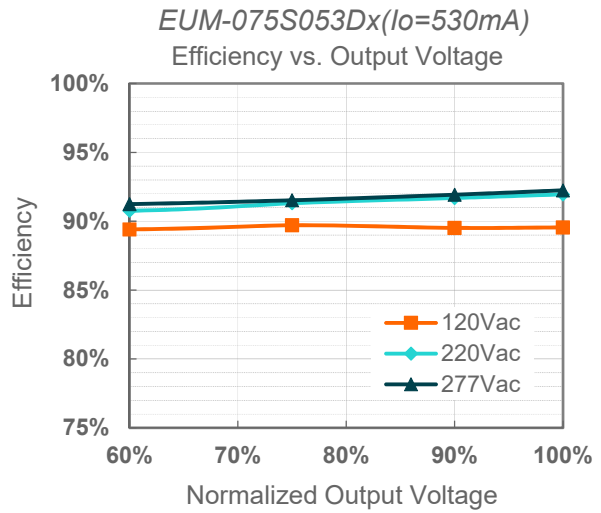
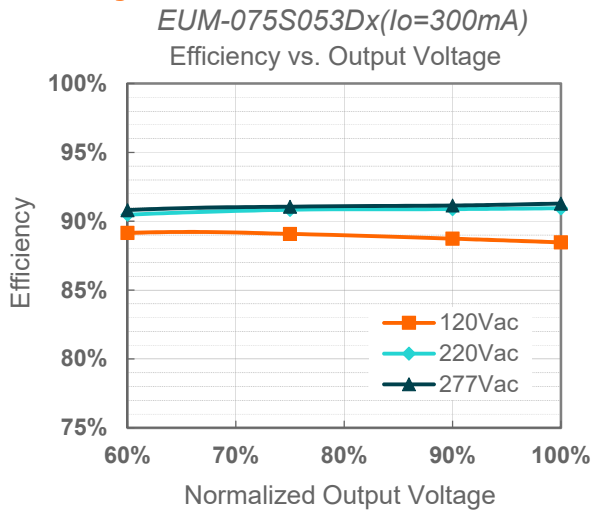

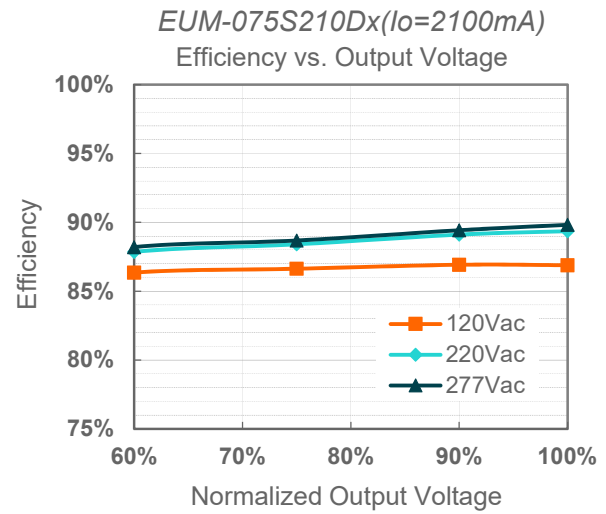
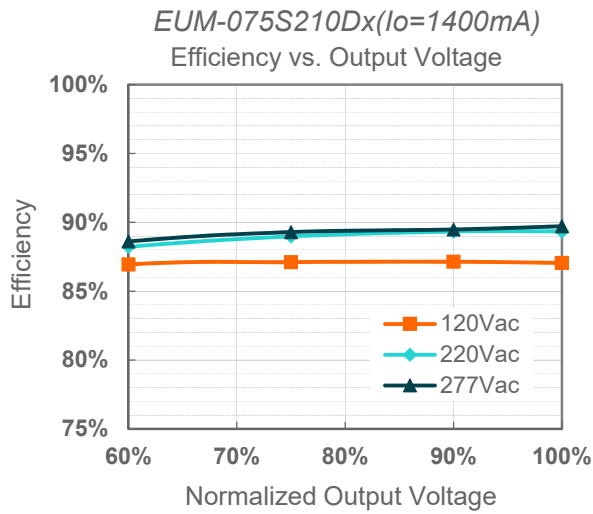

Power Factor

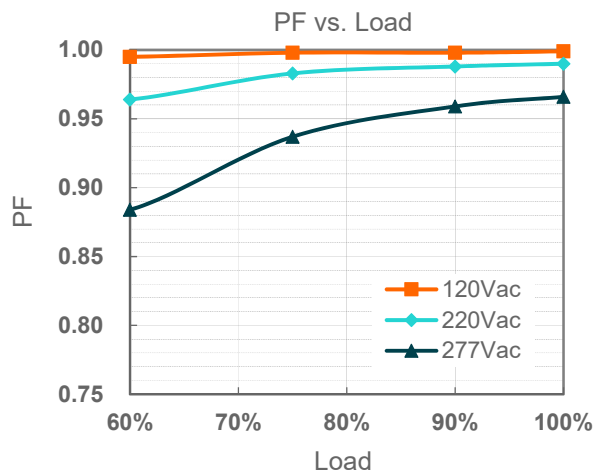

Total Harmonic Distortion

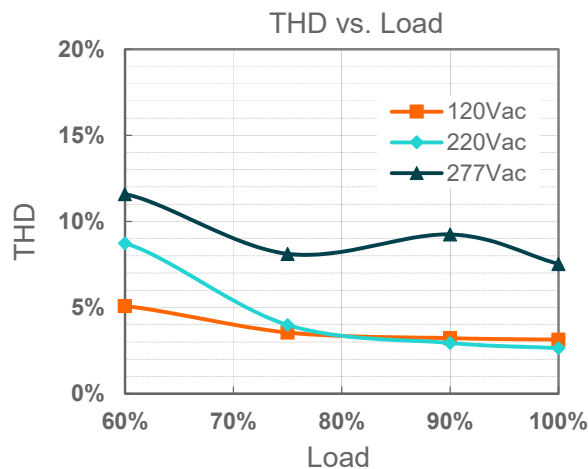

Protection Functions

Parameter	Notes
Over Temperature Protection	Decreases output current, returning to normal after over temperature is removed.
Short Circuit Protection	Auto Recovery. No damage will occur when any output is short circuited. The output shall return to normal when the fault condition is removed.
Over Voltage Protection	Limits output voltage at no load and in case the normal voltage limit fails.

Dimming

● 1-5V Dimming

The recommended implementation of the dimming control is provided below.

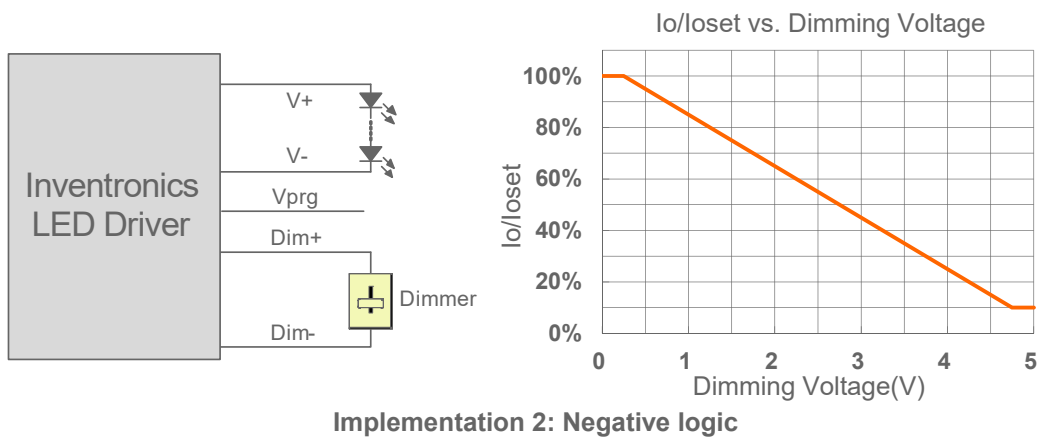
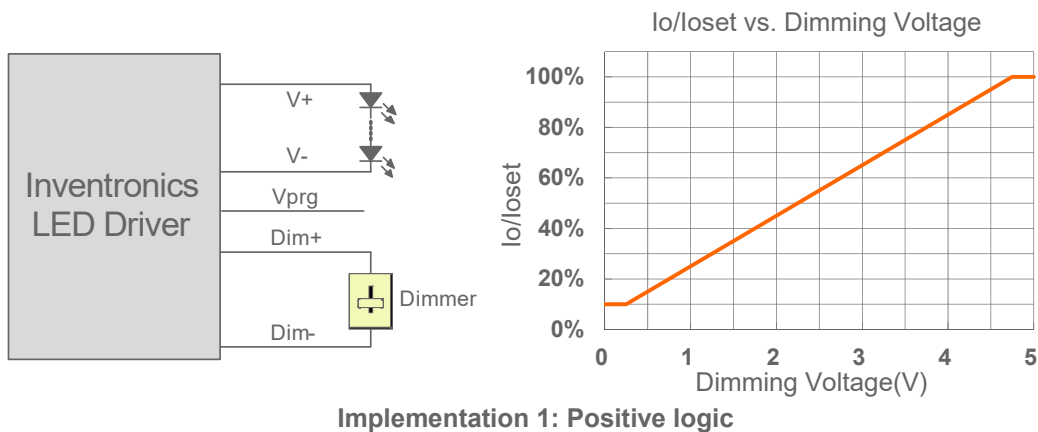

Notes:

1. Do NOT connect Dim- to the output V- or V+, otherwise the driver will not work properly.
2. The dimmer can also be replaced by an active 1-5V voltage source signal or passive components like zener.
3. When 1-5V negative logic dimming mode and Dim+ is open, the driver will output maximum current.

● 1-10V Dimming

The recommended implementation of the dimming control is provided below.

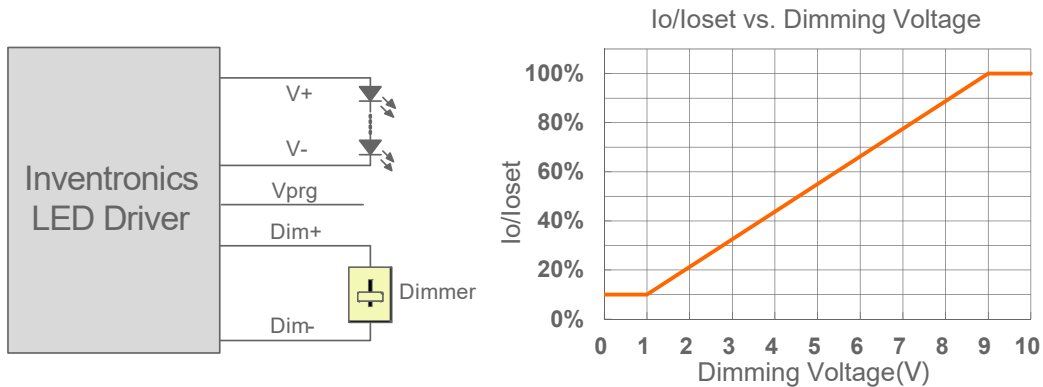

Implementation 3: Positive logic

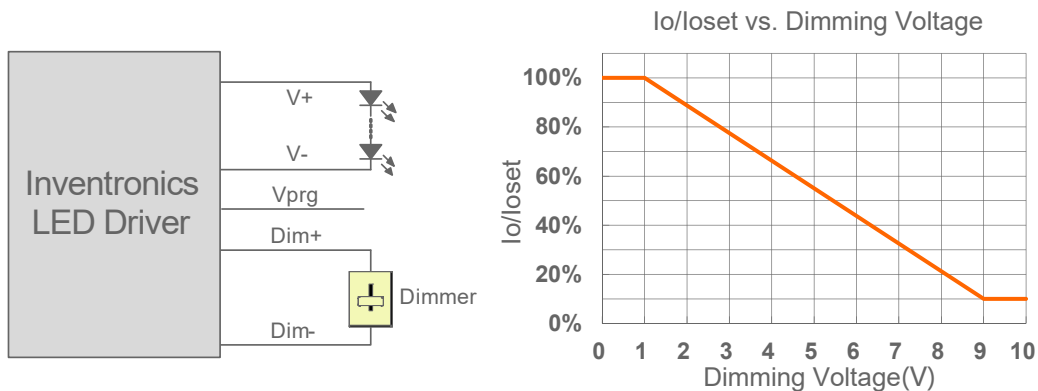

Implementation 4: Negative logic

Notes:

1. Do NOT connect Dim- to the output V- or V+, otherwise the driver will not work properly.
2. The dimmer can also be replaced by an active 1-10V voltage source signal or passive components like zener.
3. When 1-10V negative logic dimming mode and Dim+ is open, the driver will output minimum current.

● **10V PWM Dimming**

The recommended implementation of the dimming control is provided below.

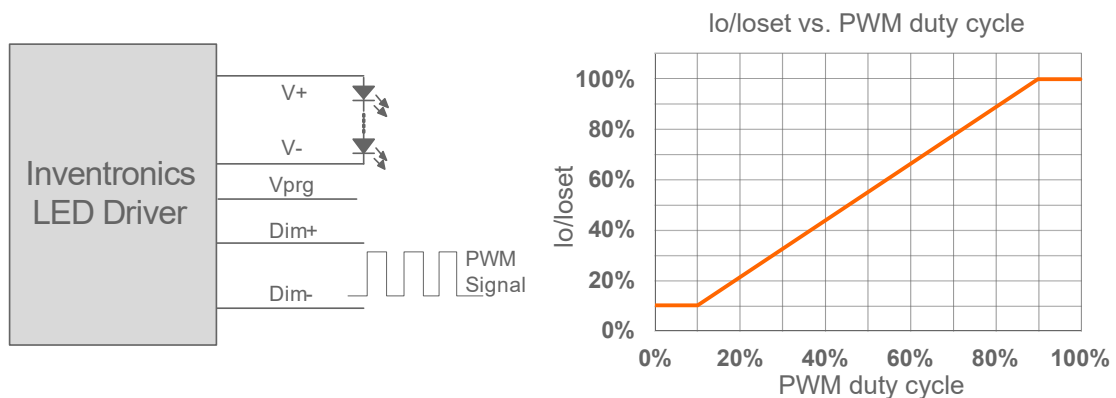

Implementation 5: Positive logic

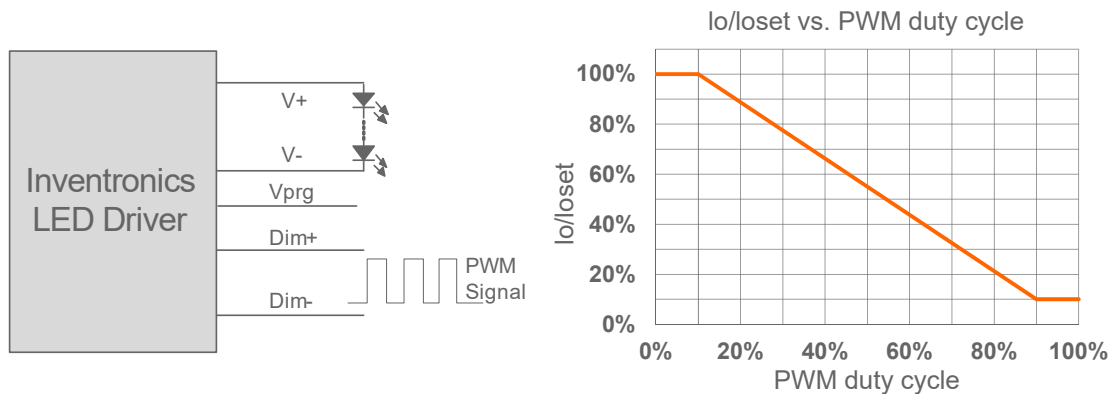

Implementation 6: Negative logic

Notes:

1. Do NOT connect Dim- to the output V- or V+, otherwise the driver will not work properly.
2. When 10V PWM negative logic dimming mode and Dim+ is open, the driver will output minimum current.

● **Time Dimming**

Time dimming control includes 3 kinds of modes, they are Self Adapting-Midnight, Self Adapting-Percentage and Traditional Timer.

- **Self Adapting-Midnight:** Automatically adjusts the dimming curve based on the on-time of past two days (if difference <15 minutes), assuming that the center point of the dimming curve is midnight local time.
- **Self Adapting-Percentage:** Automatically adjusts the on-time of each step by a constant percentage = (actual on-time for the past 2 days if difference <15 min) / (programmed on-time from the dimming curve).
- **Traditional Timer:** Follows the programmed timing curve after power on with no changes.

● **Output Lumen Compensation**

Output Lumen Compensation (OLC) may be used to maintain constant light output over the life of the LEDs by driving them at a reduced current when new, then gradually increasing the drive current over time to counteract LED lumen degradation.

Programming Connection Diagram

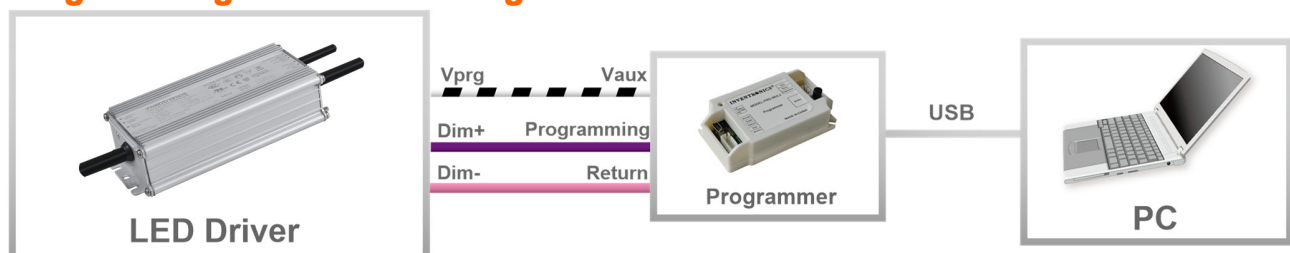

Note: The driver does not need to be powered on during the programming process.

- Please refer to [PRG-MUL2 \(Programmer\) datasheet](#) for details.

Mechanical Outline

EUM-075SxxxDG

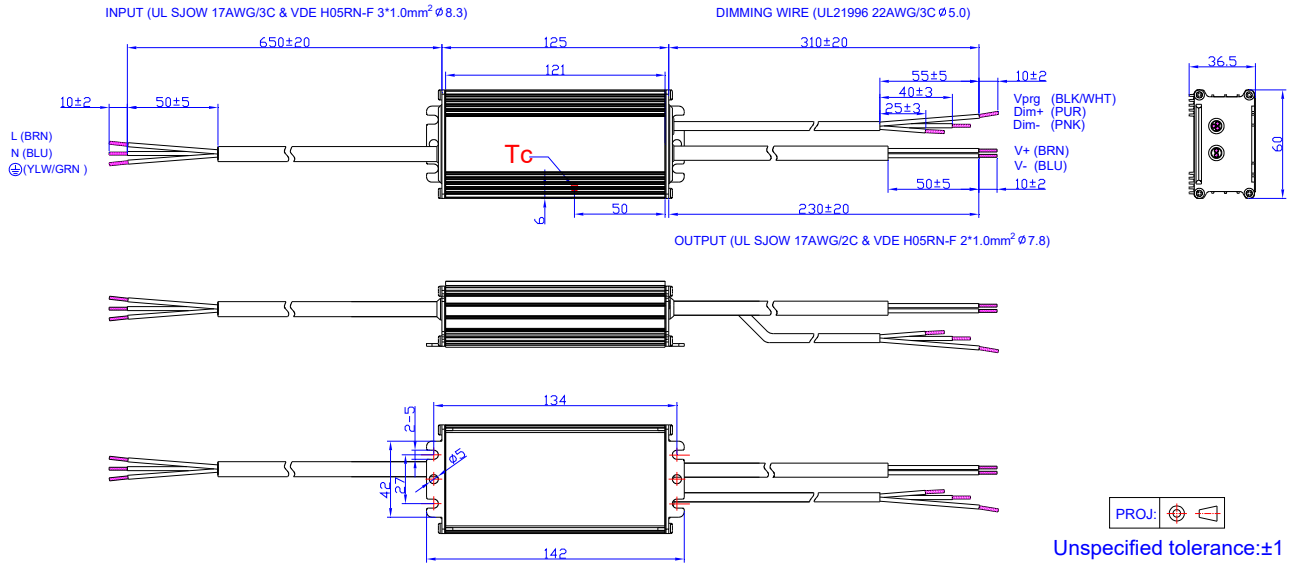

EUM-075SxxxDT

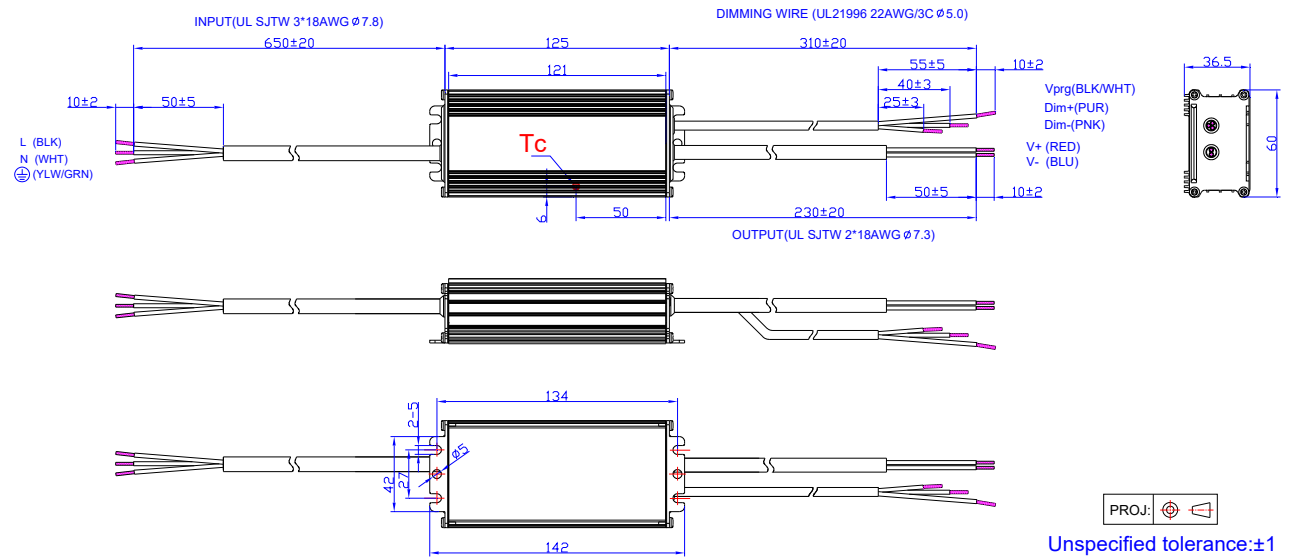

EUM-075SxxxDB

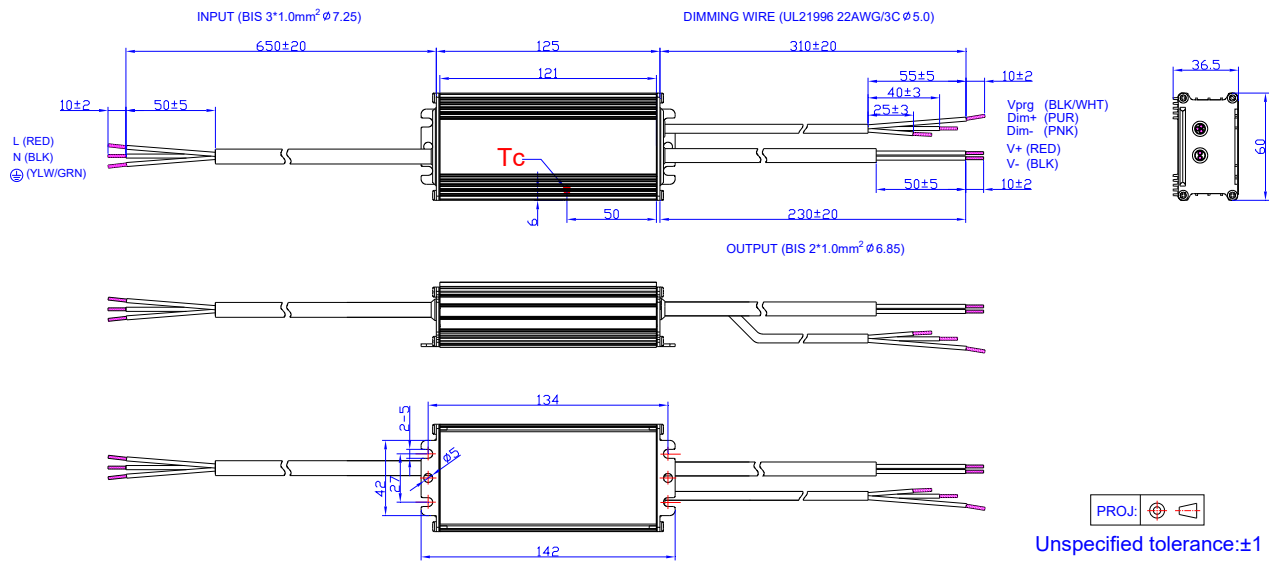

RoHS Compliance

Our products comply with reference to RoHS Directive (EU) 2015/863 amending 2011/65/EU, calling for the elimination of lead and other hazardous substances from electronic products.

Revision History

Change Date	Rev.	Description of Change		
		Item	From	To
2021-03-09	A	Datasheets Release	/	/
2021-11-04	B	UKCA logo	/	Added
		Models	EUM-075S053Dx	Added
		Models	Note (7)	Added
		I-V Operation Area	EUM-075S053Dx	Added
		Output Current Setting(losset) Range	EUM-075S053Dx	Added
		Output Current Setting Range with Constant Power	EUM-075S053Dx	Added
		No Load Output Voltage	EUM-075S053Dx	Added
		Efficiency at 120 Vac input:	EUM-075S053Dx	Added
		Efficiency at 220 Vac input:	EUM-075S053Dx	Added
		Efficiency at 277 Vac input:	EUM-075S053Dx	Added
		Dimming Output Range	EUM-075S053Dx	Added
		Safety &EMC Compliance	UKCA	Added
		Efficiency vs. Load	EUM-075S053Dx	Added
		Programming Connection Diagram	EUM-075SxxxDT	Updated
Mechanical Outline	EUM-075SxxxDT	Updated		
2023-06-16	C	Product Photograph	/	Updated
		global-mark	/	Added
		Safety &EMC Compliance	/	Updated
		Dimming	/	Updated
		Programming Connection Diagram	/	Updated
		Mechanical Outline	/	Updated
2024-09-26	D	Format	/	Updated
		Product Photograph	/	Updated
		UKCA logo	/	Deleted
		Safety &EMC Compliance	/	Updated
		Inrush Current Waveform	/	Updated