

## Features

- Full Power at Wide Output Current Range (Constant Power)
- Adjustable Output Current (AOC) with NFC
- DALI-2 and D4i Certified
- 3-Timer-Modes Dimmable
- Dim-to-Off with Standby Power  $\leq 0.5$  W
- Always-on Auxiliary Power: 24Vdc, 125mA, 3W (Transient Peak Power up to 10W)
- Integrated 16Vdc Bus Power Supply based on DALI-2
- Integrated Power Metering with High Accuracy up to  $\pm 1\%$
- Output Lumen Compensation
- End-of-Life Indicator
- Thermal Sensing and Protection for LED Module
- Input Surge Protection: DM 6kV, CM 10kV
- All-Around Protection: IUVP, IOVP, OVP, SCP, OTP
- IP66/IP67 and UL Dry/Damp/Wet Location
- TYPE HL, for use in a Class I, Division 2 Hazardous (Classified) Location
- 7 Years Warranty



## Description

The EUM-075SxxxBx series is a 75W, constant-current, NFC programmable and IP66/IP67 rated LED driver that operates from 90-305Vac input with excellent power factor. Created for intra-luminaire solutions and health monitoring applications, this family provides integrated AC power monitoring with an auxiliary voltage and dim-to-off functionality for powering low voltage, wireless controls. The dimming control supports two-way communication via DALI-2 and complies with D4i. The high efficiency of these drivers and compact metal case enables them to run cooler, significantly improving reliability and extending product life. To ensure trouble-free operation, protection is provided against input surge, input under voltage, input over voltage, output over voltage, short circuit, and over temperature.

## Models

| Adjustable Output Current Range | Full-Power Current Range (1) | Default Output Current | Input Voltage Range(2)     | Output Voltage Range | Max. Output Power | Typical Efficiency (3) | Typical Power Factor |        | Model Number (4)             |
|---------------------------------|------------------------------|------------------------|----------------------------|----------------------|-------------------|------------------------|----------------------|--------|------------------------------|
|                                 |                              |                        |                            |                      |                   |                        | 120Vac               | 220Vac |                              |
| 70-1050mA                       | 700-1050mA                   | 700 mA                 | 90~305 Vac/<br>127~300 Vdc | 36~107 Vdc           | 75W               | 90.5%                  | 0.99                 | 0.96   | EUM-075S105Bx <sup>(5)</sup> |
| 105-1500mA                      | 1050-1500mA                  | 1050 mA                | 90~305 Vac/<br>127~300 Vdc | 25~72 Vdc            | 75W               | 89.5%                  | 0.99                 | 0.96   | EUM-075S150Bx <sup>(5)</sup> |
| 140-2100mA                      | 1400-2100mA                  | 2100 mA                | 90~305 Vac/<br>127~300 Vdc | 18~54 Vdc            | 75W               | 89.0%                  | 0.99                 | 0.96   | EUM-075S210Bx <sup>(6)</sup> |

- Notes:** (1) Output current range with constant power at 75W  
 (2) Certified input voltage range: UL, FCC 100-277Vac; otherwise 100-240Vac.  
 (3) Measured at 100% load and 220Vac input (see below "General Specifications" for details).  
 (4) x = G are UL Recognized, ENEC and CCC, etc. models; x = T are UL Class P models; x = B are BIS models.  
 (5) SELV Output.  
 (6) Class 2 & SELV output.

## I-V Operation Area

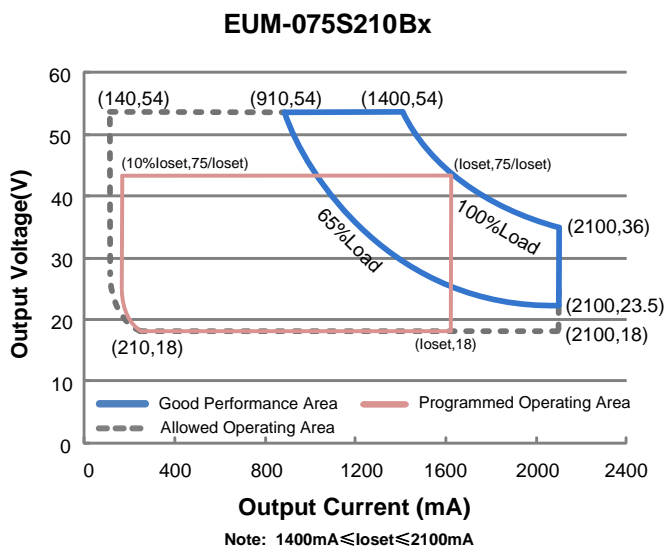
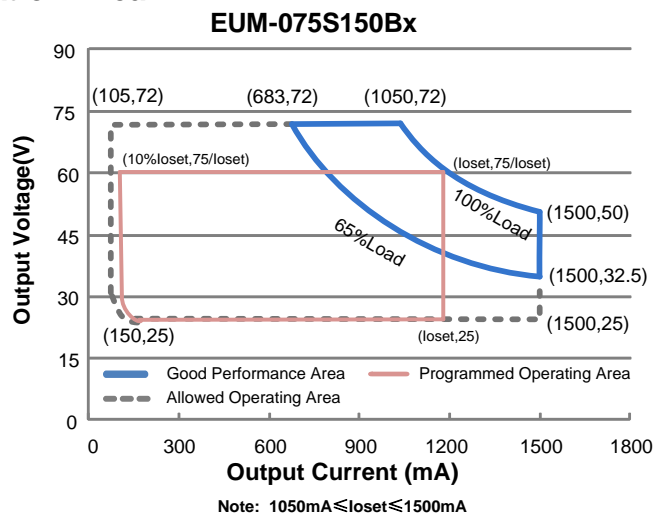
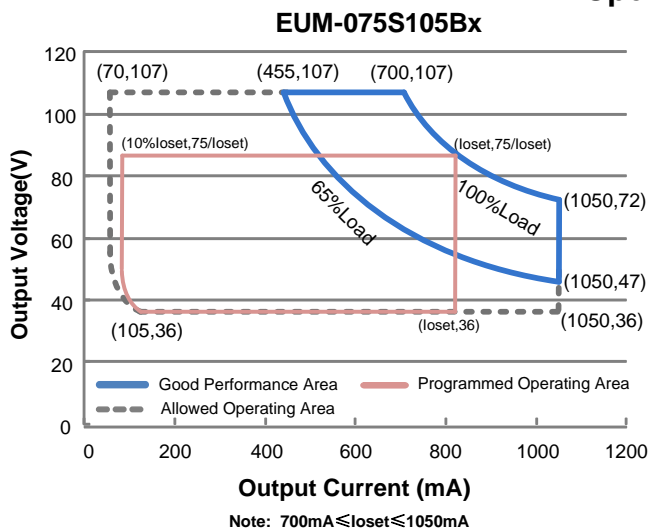

## Input Specifications

| Parameter                        | Min.    | Typ. | Max.                  | Notes  |
|----------------------------------|---------|------|-----------------------|--|
| Input AC Voltage                 | 90 Vac  | -    | 305 Vac               |  |
| Input DC Voltage                 | 127 Vdc | -    | 300 Vdc               |  |
| Input Frequency                  | 47 Hz   | -    | 63 Hz                 |  |
| Leakage Current                  | -       | -    | 0.75 MIU              | UL 8750; 277Vac/60Hz   |
|                                  | -       | -    | 0.70 mA               | IEC 60598-1; 240Vac/60Hz   |
| Input AC Current                 | -       | -    | 0.80 A                | Measured at 100% load and 120 Vac input.   |
|                                  | -       | -    | 0.44 A                | Measured at 100% load and 220 Vac input.   |
| Inrush Current(I <sup>2</sup> t) | -       | -    | 2.15 A <sup>2</sup> s | At 220Vac input, 25°C cold start, duration=512 μs, 10%I <sub>pk</sub> -10%I <sub>pk</sub> . See Inrush Current Waveform for the details. |

## Input Specifications (Continued)

| Parameter | Min. | Typ. | Max. | Notes  |
|-----------|------|------|------|--|
| PF        | 0.9  | -    | -    | At 100-277Vac, 50-60Hz, 65%-100% Load (49-75W) |
| THD       | -    | -    | 20%  |  |
| THD       | -    | -    | 10%  | At 220-240Vac, 50-60Hz, 75%-100% Load (56-75W) |

## Output Specifications

| Parameter  | Min.     | Typ.     | Max.     | Notes  |
|--|----------|----------|----------|--|
| Output Current Tolerance                         | -5%loset | -        | 5%loset  | At 100% load condition   |
| Output Current Setting(loset) Range              |          |          |          |  |
| EUM-075S105Bx                                    | 70 mA    | -        | 1050 mA  |  |
| EUM-075S150Bx                                    | 105 mA   | -        | 1500 mA  |  |
| EUM-075S210Bx                                    | 140 mA   | -        | 2100 mA  |  |
| Output Current Setting Range with Constant Power |          |          |          |  |
| EUM-075S105Bx                                    | 700 mA   | -        | 1050 mA  |  |
| EUM-075S150Bx                                    | 1050 mA  | -        | 1500 mA  |  |
| EUM-075S210Bx                                    | 1400 mA  | -        | 2100 mA  |  |
| Total Output Current Ripple (pk-pk)              | -        | 5%lomax  | 10%lomax | At 100% load condition. 20 MHz BW  |
| Output Current Ripple at < 200 Hz (pk-pk)        | -        | 2%lomax  | -        | At 100% load condition. Only this component of ripple is associated with visible flicker.                            |
| Startup Overshoot Current                        | -        | -        | 10%lomax | At 100% load condition   |
| No Load Output Voltage                           |          |          |          |  |
| EUM-075S105Bx                                    | -        | -        | 120 V    |  |
| EUM-075S150Bx                                    | -        | -        | 90 V     |  |
| EUM-075S210Bx                                    | -        | -        | 60 V     |  |
| Line Regulation                                  | -        | -        | ±1%      | Measured at 100% load  |
| Load Regulation                                  | -        | -        | ±5%      |  |
| Turn-on Delay Time                               | -        | -        | 0.5 s    | Measured at all dimming modes except DALI-2, and 120-277Vac input, 65%-100% Load                                     |
|  | -        | -        | 1.0 s    | Measured at DALI-2 dimming mode, and 120-277Vac input, 65%-100% Load   |
| Temperature Coefficient of loset                 | -        | 0.06%/°C | -        | Case temperature = 0°C ~Tc max   |
| 24V Auxiliary Output Voltage                     | 21.6 V   | 24 V     | 26.4 V   |  |
| 24V Auxiliary Output Source Current              | 0 mA     | -        | 125 mA   | Return terminal is "DA"  |
| 24V Auxiliary Output Transient Peak Current@6W   | -        | -        | 250 mA   | 250mA peak for a maximum duration of 2.2 ms in a 6.0ms period during which time the average should not exceed 125mA. |
| 24V Auxiliary Output Transient Peak Current@10W  | -        | -        | 425 mA   | 425mA peak for a maximum duration of 1.3 ms in a 5.2ms period during which time the average should not exceed 125mA. |
| Integrated DALI-2 Bus Power Supply Voltage       | 12 Vdc   | 16 Vdc   | 20 Vdc   | Voltage is depending on loading.   |

## Output Specifications (Continued)

| Parameter   | Min. | Typ.  | Max. | Notes                                      |
|---|------|-------|------|--|
| Integrated DALI-2 Bus Power Maximum Supply Current    |      | 60 mA |      |  |
| Integrated DALI-2 Bus Power Guaranteed Supply Current |      | 50 mA |      | DALI-2 Bus Power Supply Voltage $\geq 12V$ |

**Notes:** (1) DALI-2 bus power supply is enabled by default and can be disabled via programming interface.  
 (2) DALI-2 bus power supply supports automatic shut-down and restart after short-circuit.

## General Specifications

| Parameter   | Min.   | Typ.   | Max.                       | Notes   |
|---|--|--|----------------------------|---|
| Efficiency at 120 Vac input:<br>EUM-075S105Bx<br>I <sub>o</sub> = 700 mA<br>I <sub>o</sub> =1050 mA<br>EUM-075S150Bx<br>I <sub>o</sub> =1050 mA<br>I <sub>o</sub> =1500 mA<br>EUM-075S210Bx<br>I <sub>o</sub> =1400 mA<br>I <sub>o</sub> =2100 mA | 86.0%<br>85.5%<br>85.0%<br>85.0%<br>84.5%<br>84.0% | 88.0%<br>87.5%<br>87.0%<br>87.0%<br>86.5%<br>86.0% | -<br>-<br>-<br>-<br>-<br>- | Measured at 100% load and steady-state temperature in 25°C ambient;<br>(Efficiency will be about 2.0% lower if measured immediately after startup.) |
| Efficiency at 220 Vac input:<br>EUM-075S105Bx<br>I <sub>o</sub> = 700 mA<br>I <sub>o</sub> =1050 mA<br>EUM-075S150Bx<br>I <sub>o</sub> =1050 mA<br>I <sub>o</sub> =1500 mA<br>EUM-075S210Bx<br>I <sub>o</sub> =1400 mA<br>I <sub>o</sub> =2100 mA | 88.5%<br>88.0%<br>87.5%<br>87.5%<br>87.0%<br>86.5% | 90.5%<br>90.0%<br>89.5%<br>89.5%<br>89.0%<br>88.5% | -<br>-<br>-<br>-<br>-<br>- | Measured at 100% load and steady-state temperature in 25°C ambient;<br>(Efficiency will be about 2.0% lower if measured immediately after startup.) |
| Efficiency at 277 Vac input:<br>EUM-075S105Bx<br>I <sub>o</sub> = 700 mA<br>I <sub>o</sub> =1050 mA<br>EUM-075S150Bx<br>I <sub>o</sub> =1050 mA<br>I <sub>o</sub> =1500 mA<br>EUM-075S210Bx<br>I <sub>o</sub> =1400 mA<br>I <sub>o</sub> =2100 mA | 88.5%<br>88.0%<br>88.0%<br>88.0%<br>87.5%<br>87.0% | 90.5%<br>90.0%<br>90.0%<br>90.0%<br>89.5%<br>89.0% | -<br>-<br>-<br>-<br>-<br>- | Measured at 100% load and steady-state temperature in 25°C ambient;<br>(Efficiency will be about 2.0% lower if measured immediately after startup.) |
| Power Metering Accuracy   | -1%  | -  | 1%                         | Measured at 220Vac input and 100%Load   |
| Standby Power   | -  | -  | 0.5 W                      | Measured at 230Vac/50Hz; Dimming off  |
| MTBF  | -  | 476,000 Hours                                      | -                          | Measured at 220Vac input, 80%Load and 25°C ambient temperature (MIL-HDBK-217F)  |
| Lifetime  | -  | 101,000 Hours                                      | -                          | Measured at 220Vac input, 80%Load and 70°C case temperature; See lifetime vs. T <sub>c</sub> curve for the details                                  |
| Operating Case Temperature for Safety T <sub>c_s</sub>  | -40°C  | -  | +90°C                      | Humidity: 10% RH to 95% RH<br>No Condensation   |
| Storage Temperature   | -40°C  | -  | +85°C                      | Humidity: 5%RH to 95%RH   |

## General Specifications (Continued)

| Parameter   | Min. | Typ.                                    | Max. | Notes  |
|---|------|---|------|--|
| Dimensions<br>Inches (L x W x H)<br>Millimeters (L x W x H) |      | 4.92 x 2.66 x 1.44<br>125 x 67.5 x 36.5 |      | With mounting ear<br>5.59 x 2.66 x 1.44<br>142 x 67.5 x 36.5 |
| Net Weight  | -    | 670 g                                   | -    |  |

## Dimming Specifications

| Parameter            | Min.  | Typ.                      | Max.  | Notes |  |
|----------------------|---|---------------------------|-------|-------|--|
| DA+, DA- High Level  | 9.5V  | 16V                       | 22.5V |       |  |
| DA+, DA- Low Level   | -6.5V   | 0V                        | 6.5V  |       |  |
| DA+, DA- Current     | 0mA   | -                         | 2mA   |       |  |
| Dimming Output Range | EUM-075S105Bx<br>EUM-075S150Bx<br>EUM-075S210Bx | 10%loset                  | -     | loset | 700 mA ≤ loset ≤ 1050 mA<br>1050 mA ≤ loset ≤ 1500 mA<br>1400 mA ≤ loset ≤ 2100 mA |
|                      | EUM-075S105Bx<br>EUM-075S150Bx<br>EUM-075S210Bx | 70 mA<br>105 mA<br>140 mA | -     | loset | 70 mA ≤ loset < 700 mA<br>105 mA ≤ loset < 1050 mA<br>140 mA ≤ loset < 1400 mA     |

## Safety & EMC Compliance

| Safety Category | Standard  |
|-----------------|---|
| UL/CUL          | UL 8750, CAN/CSA-C22.2 No. 250.13   |
| ENEC            | EN 61347-1, EN 61347-2-13   |
| UKCA            | BS EN 61347-1, BS EN 61347-2-13<br>BS EN 301 489-1<br>BS EN 301 489-3<br>BS EN 300 330<br>BS EN 62479/BS EN 50663/BS EN 50665/BS EN 50364 |
| CE              | EN 61347-1, EN 61347-2-13<br>EN 301 489-1<br>EN 301 489-3<br>EN 300 330<br>EN 62479/EN 50663/EN 50665/EN 50364                            |
| CB              | IEC 61347-1, IEC 61347-2-13   |
| CCC             | GB 19510.1, GB 19510.14   |
| PSE             | J 61347-1, J 61347-2-13   |
| KS              | KS C 7655   |
| BIS             | IS 15885(Part2/Sec13)   |
| NOM             | NOM-058-SCFI  |
| EAC             | TP TC 004, TP TC 020  |
| SAA             | AS/NZS 61347.1, AS/NZS 61347.2.13   |

## Safety & EMC Compliance (Continued)

| Performance  | Standard  |
|--|---|
| ENEC   | EN 62384  |
| EMI Standards                                      | Notes   |
| BS EN/EN IEC 55015/GB/T 17743/KN 15 <sup>(1)</sup> | Conducted emission Test & Radiated emission Test  |
| BS EN/EN IEC 61000-3-2/GB 17625.1                  | Harmonic current emissions  |
| BS EN/EN 61000-3-3                                 | Voltage fluctuations & flicker  |
| FCC Part 15 <sup>(1)</sup>                         | ANSI C63.4 Class B  |
|  | This device complies with Part 15 of the FCC Rules. Operation is subject to the following two conditions: [1] this device may not cause harmful interference, and [2] this device must accept any interference received, including interference that may cause undesired Operation. |
| EMS Standards                                      | Notes   |
| BS EN/EN 61000-4-2                                 | Electrostatic Discharge (ESD): 8 kV air discharge, 4 kV contact discharge   |
| BS EN/EN 61000-4-3                                 | Radio-Frequency Electromagnetic Field Susceptibility Test-RS  |
| BS EN/EN 61000-4-4                                 | Electrical Fast Transient / Burst-EFT   |
| BS EN/EN 61000-4-5                                 | Surge Immunity Test: AC Power Line: Differential Mode 6 kV, Common Mode 10 kV   |
| BS EN/EN 61000-4-6                                 | Conducted Radio Frequency Disturbances Test-CS  |
| BS EN/EN 61000-4-8                                 | Power Frequency Magnetic Field Test   |
| BS EN/EN 61000-4-11                                | Voltage Dips  |
| BS EN/EN 61547                                     | Electromagnetic Immunity Requirements Applies To Lighting Equipment   |
| DALI-2 Standards                                   | Notes   |
| DALI-2 <sup>(2)</sup>                              | IEC 62386-101, -102 & -207  |

**Note:** (1) This LED driver meets the EMI specifications above, but EMI performance of a luminaire that contains it depends also on the other devices connected to the driver and on the fixture itself.

(2) DALI Parts: 101, 102, 150, 207, 250, 251, 252, 253.

## Derating

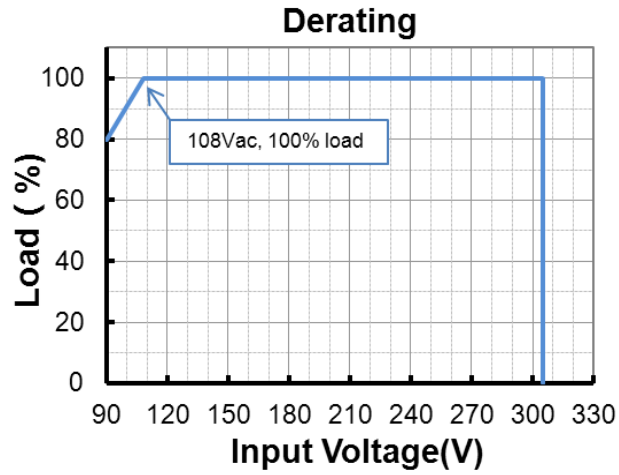

## Lifetime vs. Case Temperature

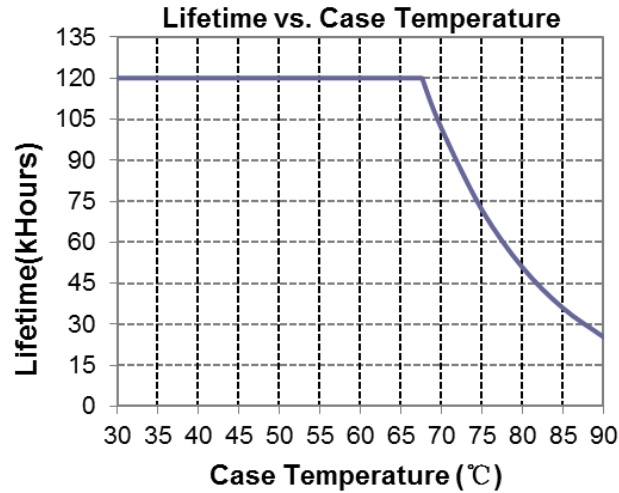

## Inrush Current Waveform

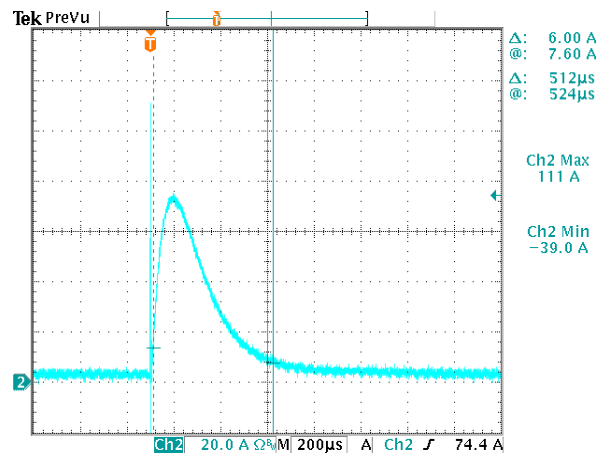

## Efficiency vs. Load

*EUM-075S105Bx*( $I_o=700mA$ )  
Efficiency vs. Output Voltage

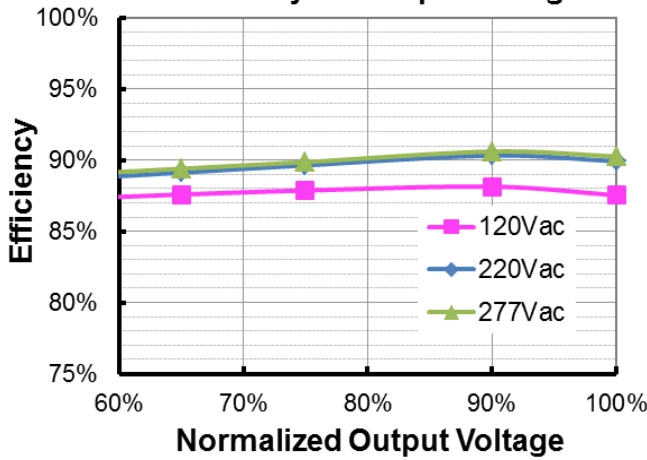

*EUM-075S105Bx*( $I_o=1050mA$ )  
Efficiency vs. Output Voltage

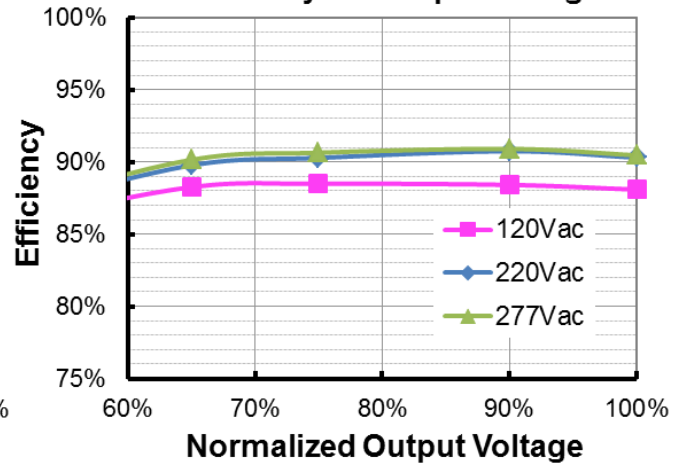

*EUM-075S150Bx*( $I_o=1050mA$ )  
Efficiency vs. Output Voltage

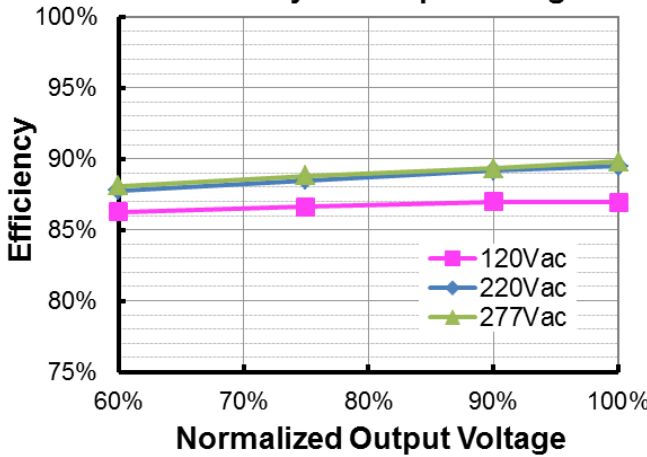

*EUM-075S150Bx*( $I_o=1500mA$ )  
Efficiency vs. Output Voltage

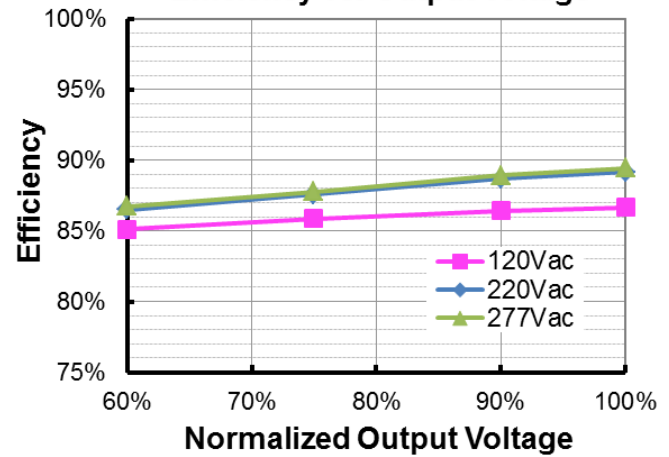

*EUM-075S210Bx*( $I_o=1400mA$ )  
Efficiency vs. Output Voltage

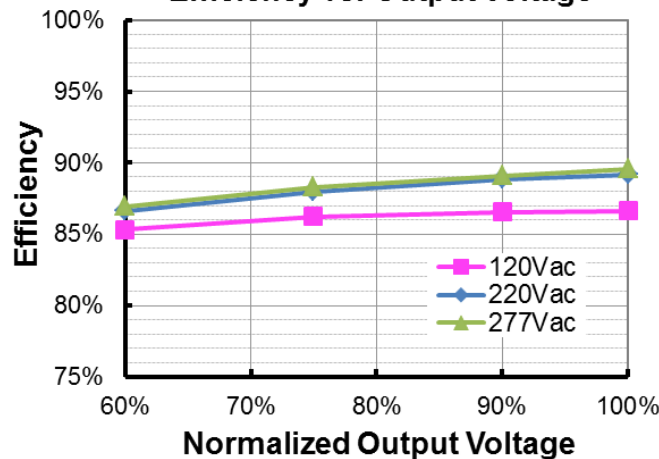

*EUM-075S210Bx*( $I_o=2100mA$ )  
Efficiency vs. Output Voltage

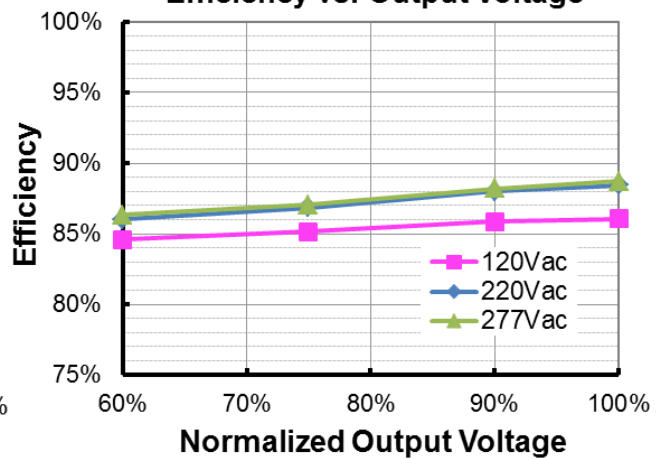



## Power Factor

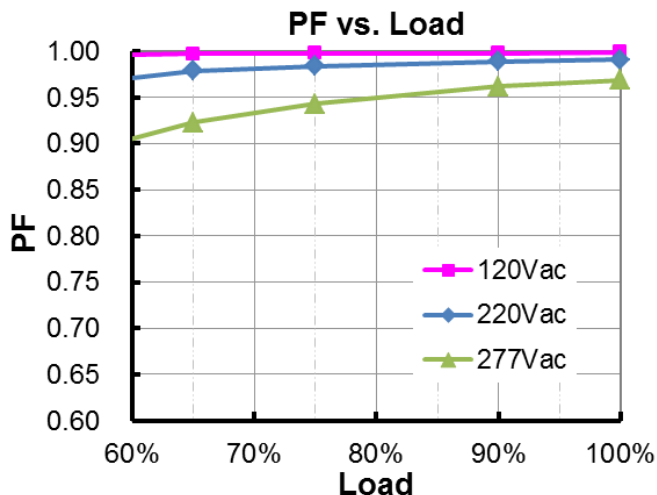

## Total Harmonic Distortion

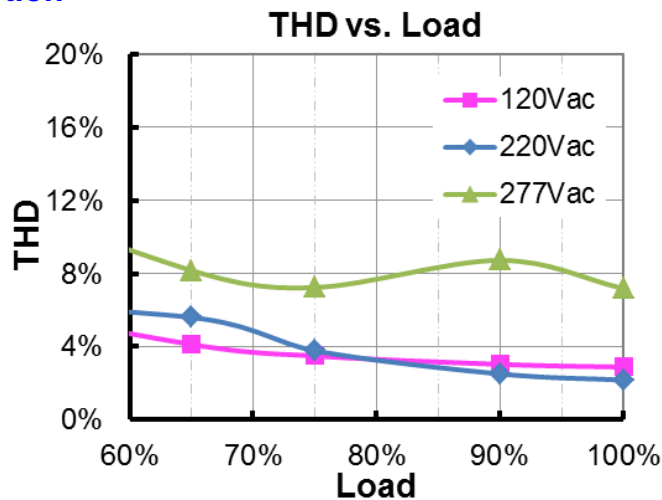

## Protection Functions

| Parameter                   |                                  | Min.   | Typ.      | Max.  | Notes   |
|-----------------------------|----------------------------------|--|-----------|---|---|
| External Thermal Protection | R1 (Start derating)              | -  | 1.67 kΩ   | -   | The output current starts to decrease linearly when the actual NTC resistance value is lower than R1, until R2 is reached.      |
|                             | R2 (Stop derating)               | -  | 1.27 kΩ   | -   | When the actual NTC resistance value is lower than R2, the output current will stay at the programmed Protection Current Floor. |
|                             | Protection Current Setting Range | 10%loset   | 20%loset  | 100%loset   | 10%loset > I <sub>omin</sub> (default setting is 20%)   |
| I <sub>omin</sub>           |                                  | 20%loset   | 100%loset | 10%loset ≤ I <sub>omin</sub> (default setting is 20%) |   |
| Over Voltage Protection     |                                  | Limits output voltage at no load and in case the normal voltage limit fails.   |           |   |   |
| Short Circuit Protection    |                                  | Auto Recovery. No damage will occur when any output is short circuited. The output shall return to normal when the fault condition is removed. |           |   |   |
| Over Temperature Protection |                                  | Decreases output current, returning to normal after over temperature is removed.   |           |   |   |

## Protection Functions (Continued)

| Parameter                             |                                | Min.    | Typ.    | Max.    | Notes  |
|---------------------------------------|--------------------------------|---------|---------|---------|--|
| Input Under Voltage Protection (IUVP) | Input Under Voltage Protection | 70 Vac  | 80 Vac  | 90 Vac  | Turn off the output when the input voltage falls below protection voltage.                           |
|                                       | Input Under Voltage Recovery   | 75 Vac  | 85 Vac  | 95 Vac  | Auto Recovery. The driver will restart when the input voltage exceeds recovery voltage.              |
| Input Over Voltage Protection (IOVP)  | Input Over Voltage Protection  | 310 Vac | 320 Vac | 330 Vac | Turn off the output when the input voltage exceeds protection voltage.                               |
|                                       | Input Over Voltage Recovery    | 300 Vac | 310 Vac | 320 Vac | Auto Recovery. The driver will restart when the input voltage falls below recovery voltage.          |
|                                       | Max. of Input Over Voltage     | -       | -       | 350 Vac | The driver can survive stabilized input over voltage conditions up to 350Vac for a total of 8 hours. |

**Note:** (1) The recommended NTC type is 10kΩ NTC, Murata NCP18XH103J03RB.

### ● Input Under Voltage Protection Diagram

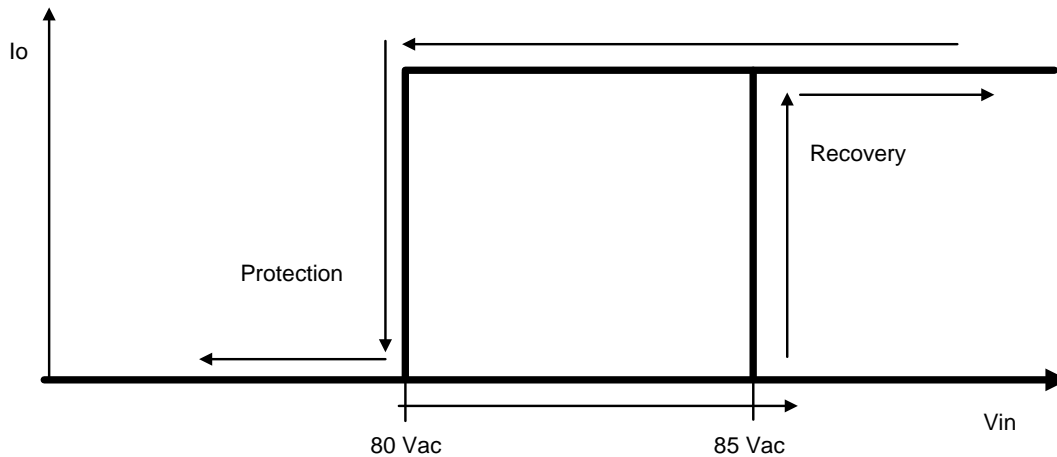

### ● Input Over Voltage Protection Diagram

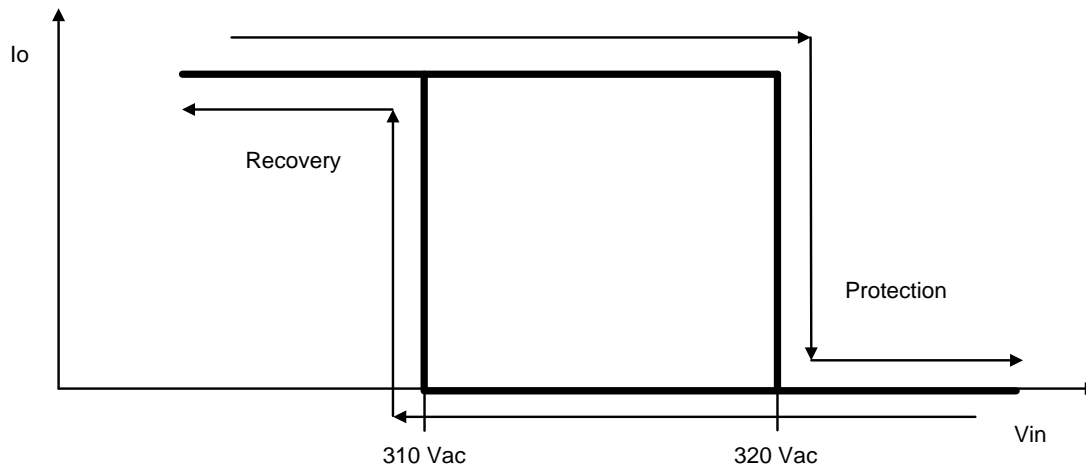

## Dimming

### ● DALI-2 Dimming

The recommended implementation of the dimming control is provided below.

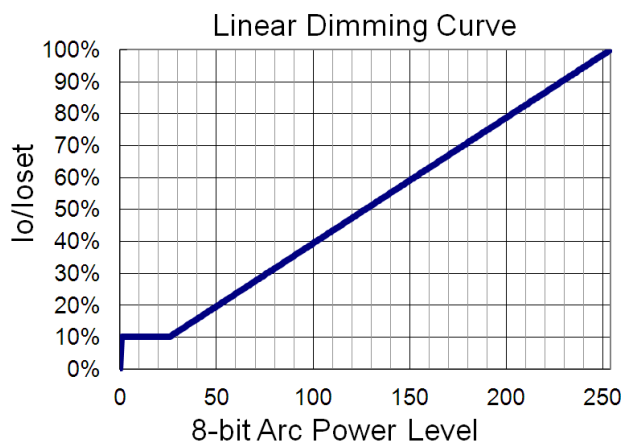
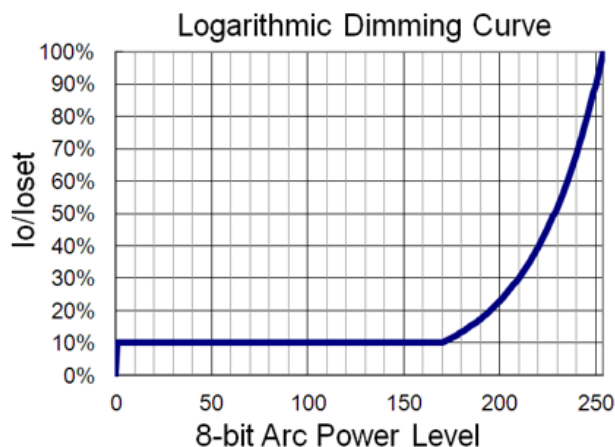
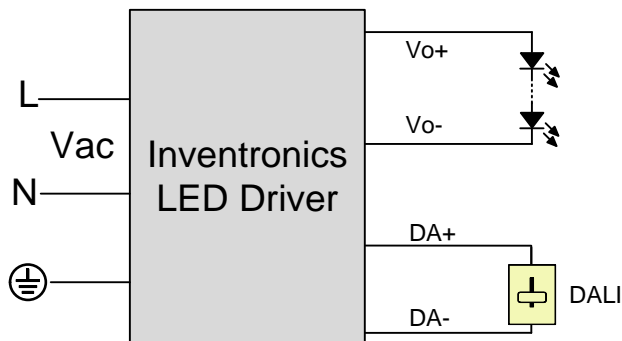

### Implementation: DALI-2 Dimming

### ● Time Dimming

Time dimming control includes 3 kinds of modes, they are Self Adapting-Midnight, Self Adapting-Percentage and Traditional Timer.

- **Self Adapting-Midnight:** Automatically adjusts the dimming curve based on the on-time of past two days (if difference <15 minutes), assuming that the center point of the dimming curve is midnight local time.
- **Self Adapting-Percentage:** Automatically adjusts the on-time of each step by a constant percentage = (actual on-time for the past 2 days if difference <15 min) / (programmed on-time from the dimming curve).
- **Traditional Timer:** Follows the programmed timing curve after power on with no changes.

### ● Output Lumen Compensation

Output Lumen Compensation (OLC) may be used to maintain constant light output over the life of the LEDs by driving them at a reduced current when new, then gradually increasing the drive current over time to counteract LED lumen degradation.

● **End Of Life**

End-of-Life (EOL) is providing a visual notification to a user that the LED module has reached the end of manufacturer-specified life and that the replacement is recommended. Once active, an indication is given at each power-up of the driver, which the driver indicates this through a lower light output during the first 1 minute before normal operation is continued.

**Programming Connection Diagram**

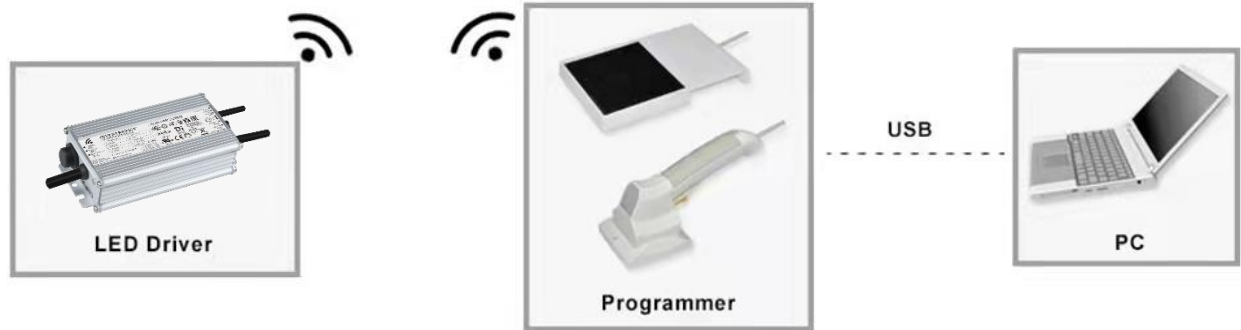

**Note:** The driver does not need to be powered on during the programming process.

● Please refer to [PRG-NFC-H](#) or [PRG-NFC-D2](#) (Programmer) datasheet for details.

**Mechanical Outline**

EUM-075SxxxBG

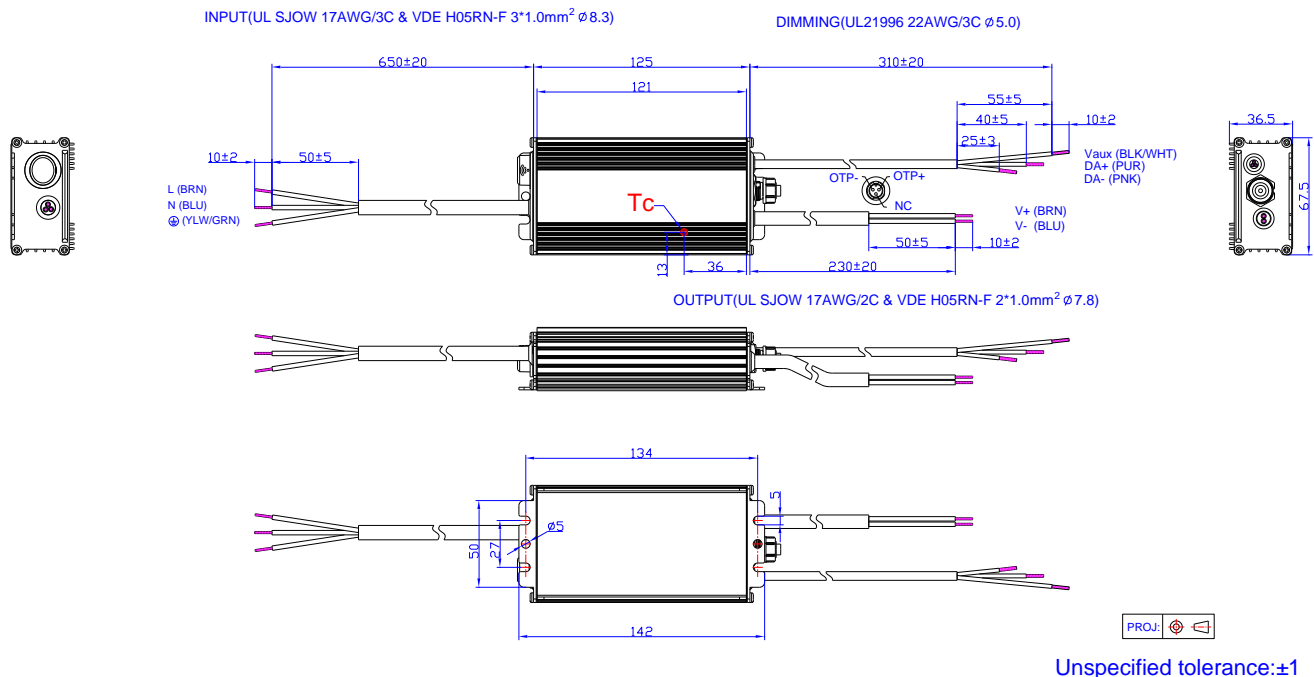

Unspecified tolerance: ±1

EUM-075SxxxBT

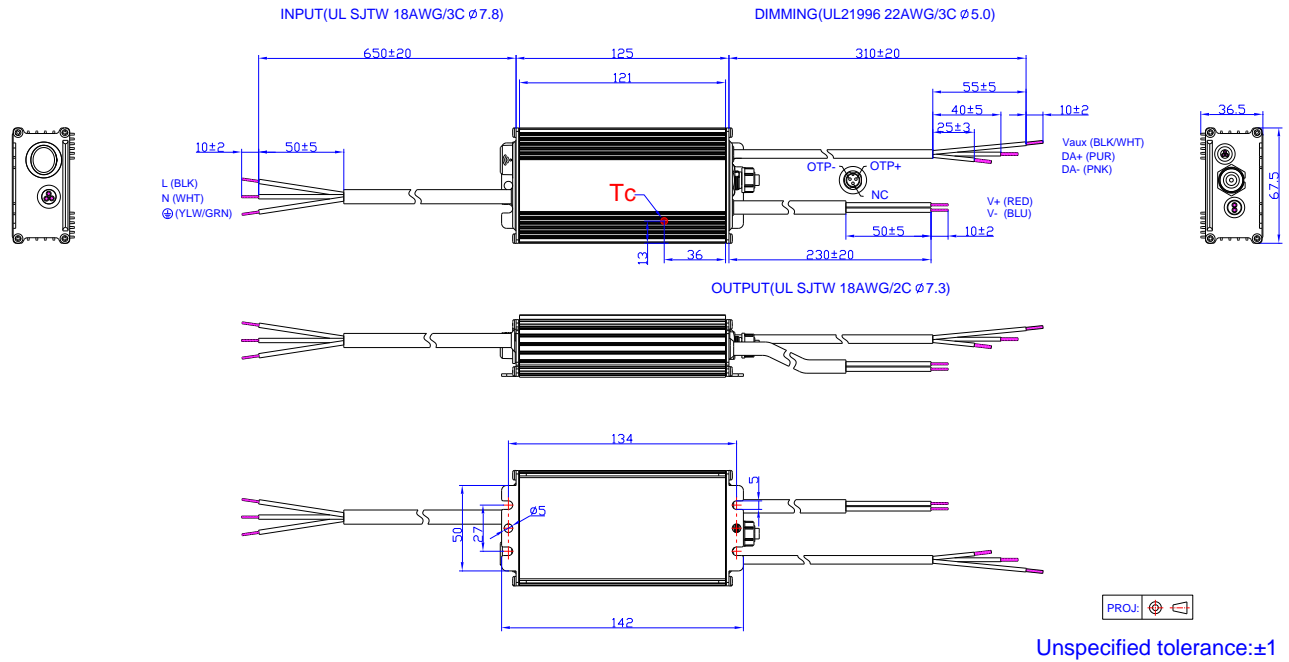

EUM-075SxxxBB

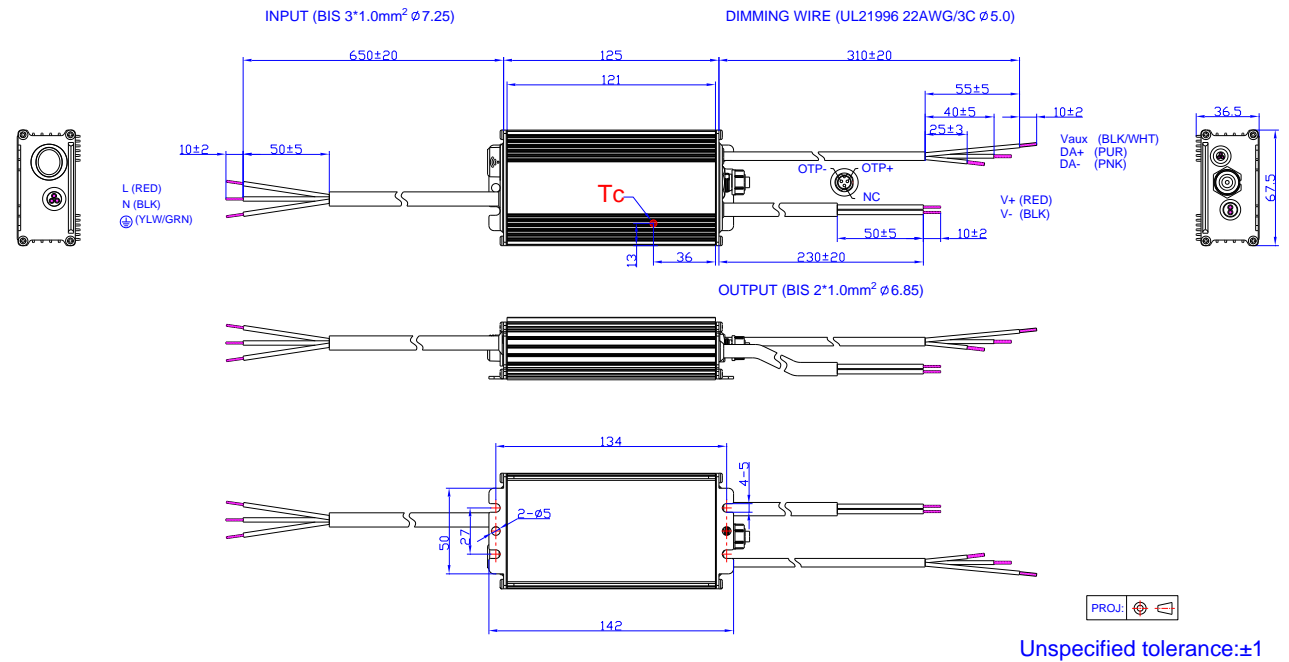

## Optional Cable Parts

### CAB-OTPG

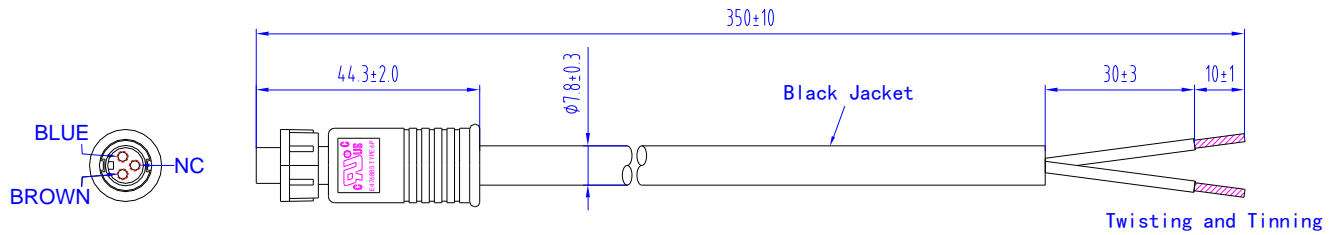

- The external thermal protection cable used for the EUM series drivers can be supplied by Inventronics, please contact the sales for ordering if necessary. For the details of cable, please refer to [CAB-OTPG \(Cable\) datasheet](#).

## RoHS Compliance

Our products comply with reference to RoHS Directive (EU) 2015/863 amending 2011/65/EU, calling for the elimination of lead and other hazardous substances from electronic products.

## Revision History

| Change Date | Rev. | Description of Change          |                                  |         |
|-------------|------|--------------------------------|----------------------------------|---------|
|             |      | Item                           | From                             | To      |
| 2020-10-22  | A    | Datasheet Release              | /                                | /       |
| 2021-01-21  | B    | Input Specifications           | Inrush Current(I <sup>2</sup> t) | Updated |
|             |      | Inrush Current Waveform        | /                                | Updated |
| 2021-06-02  | C    | Product Photograph             | /                                | Updated |
|             |      | EAC logo                       | /                                | Added   |
|             |      | Safety &EMC Compliance         | /                                | Updated |
|             |      | Mechanical Outline             | /                                | Updated |
| 2021-12-17  | D    | UKCA logo                      | /                                | Added   |
|             |      | SAA logo                       | /                                | Updated |
|             |      | Safety &EMC Compliance         | UKCA                             | Added   |
|             |      | Mechanical Outline             | EUM-075SxxxBT                    | Updated |
| 2023-07-13  | E    | Product Photograph             | /                                | Updated |
|             |      | NOM logo                       | /                                | Added   |
|             |      | Output Specifications          | /                                | Updated |
|             |      | Safety & EMC Compliance        | /                                | Updated |
|             |      | Dimming                        | /                                | Updated |
|             |      | Programming Connection Diagram | /                                | Updated |
|             |      | Mechanical Outline             | /                                | Updated |