

## Installation Guidelines

The document is to guide how to operate NFS-900-BC/NSS-1K2-BC driver for achieving reliable installation.

### 1. Assembly guideline-Prevention of Moisture Ingress for Outdoor Application

The driver is intended for use in multiple outdoor lighting applications, such as sports lighting, high mast, etc. Please follow the assembly guidelines below to prevent ingress of moisture and other particles.

#### Section 1. Assemble end-cap and gland connector

It is critical to use appropriate tools to fix the screws and the glands, please refer to table below for the recommendation. Meanwhile, the 'body nut' of the gland should be secured during tightening gland caps.

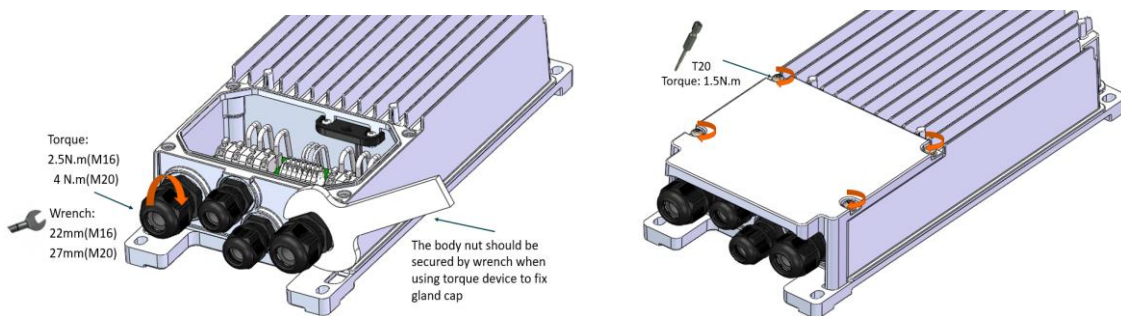

#### Section 2. Assemble cable on the driver

##### a. Dis-assemble end-cap and gland connector

Please follow the operation guideline in section 1.

##### b. Assemble and Dis-assemble wire leads from terminals



*Note: During and after installation, the wires of Input/Output/Dimming inside the wiring compartment shall be reliably separated by at least 6.35mm from each other.*

##### c. Re-assemble end-cap and gland connector

Ensure the white gasket below is properly fitted in the groove of the upper lid, and please change this white gasket immediately if it is worn-out to achieve reliable sealing performance. The four screws are fastened by tool in a diagonal sequence. Please also follow the operation guideline in section 1.



## 2. Installation notes

### a. Recommended cable spec for the gland connectors

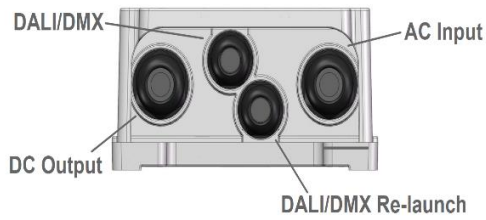

Connection	Cable Gland	Toque (N·m)	Cable Diameter (mm)	Cable AWG	Cable Section (mm <sup>2</sup> )	Strip Length (mm)
AC Input	M20	4	6.5-10.2	18-14	1.0-2.5	9-10
DC Output	M20	4	6.5-10.2	18-14	1.0-2.5	9-10
DALI/DMX	M16	2.5	6.5-10	18-16	0.75-1.5	9-10
DALI/DMX Re-launch	M16	2.5	6.5-10	18-16	0.75-1.5	9-10

Note: All gland connectors should be used during field operation. Larger sealings are available on request.

### b. Functions definition for different terminals

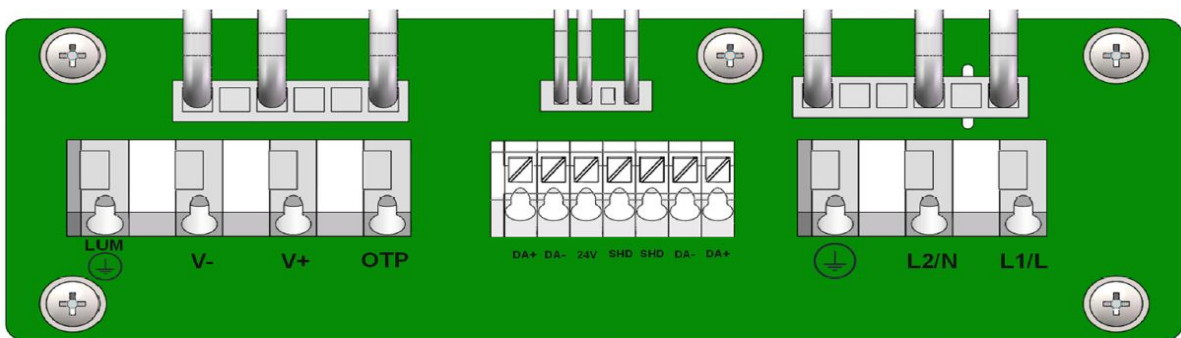

Note: Wires spec for terminals please refer table above.

### c. Output wires size recommendation

The recommended cross-sectional area of the wires is depicted below for reducing voltage drop, and the other wires size can be also used after system evaluation

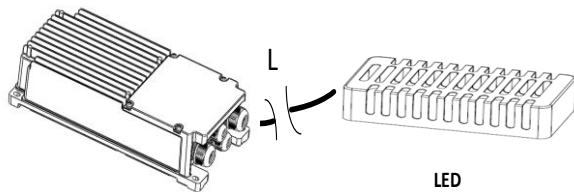

L < 100m: Wire Size 1.5 mm<sup>2</sup>  
 100 m < L < 300m: Wire Size 2.5 mm<sup>2</sup>

Note: The driver must be reliably and firmly grounded in the installation.

### d. Installation and Thermal Management

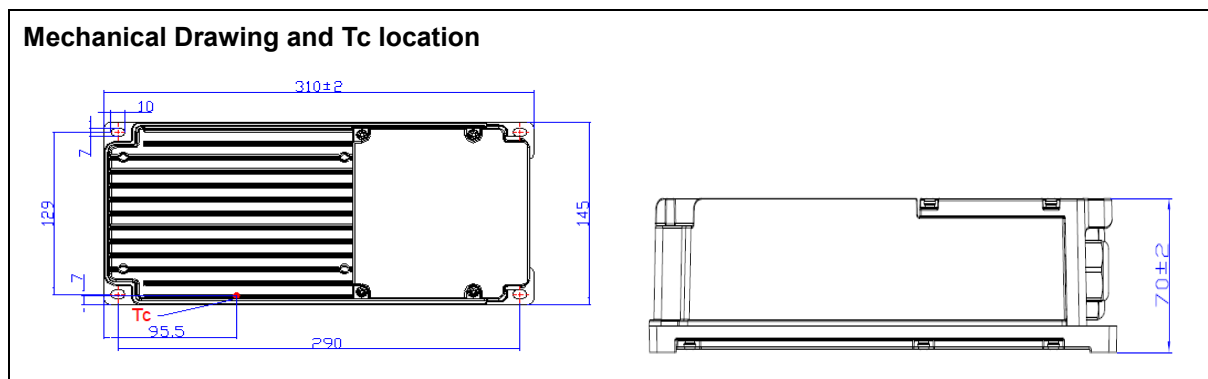

## Installation Orientation and Thermal Management

The distance between drivers and side walls is recommended as shown in drawing, the thermal testing suggested to be evaluated under real installation and application conditions, and ensure its case temperature is lower than 80 C warranty Tc.

A painted cabinet enclosure suggested to be selected with high reflectance ratio to reduce solar radiant heat.

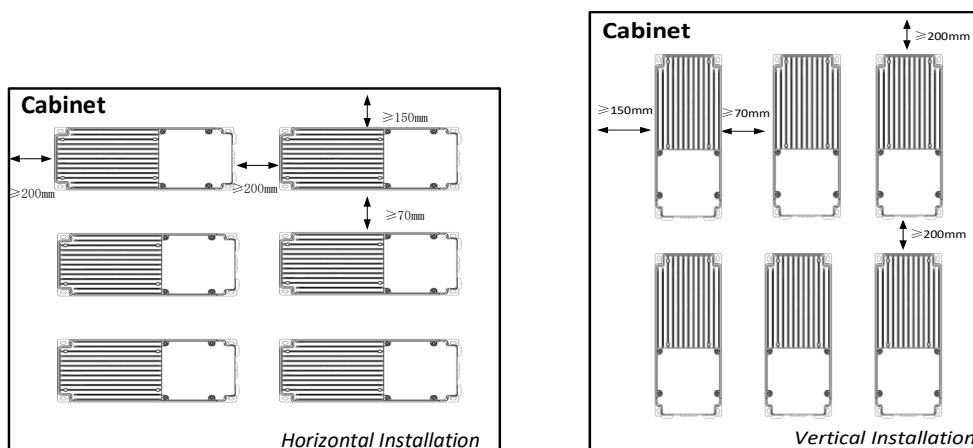

The installation orientations are not recommended for the outside exposure application as right illustration shown.

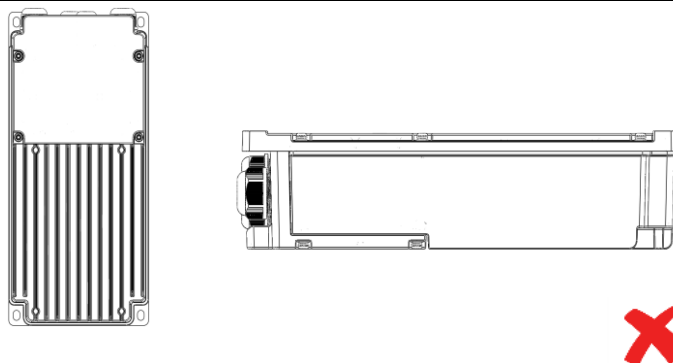

e. **Other notes** please refer to Inventronics standard installation manual below and datasheet

**The installation will be executed by a qualified electrician, and operation only be done without energizing driver**

*The control circuitries of driver defined as class 2 and SELV level, the external connected circuitries should be equivalent*

**RISK OF ELECTRIC SHOCK.THE POWER SOURCE MUST BE OFF 120S BEFORE INSTALLATION AND OPERATION.**

<https://www.inventronics-co.com/wp-content/uploads/2018/09/Installation-Instructions%EF%BC%9ALED-Drivers.pdf>

### 3. The isolation levels between circuits

	AC Input	DC Output	Dimming (SELV)	Housing
AC Input	/	No isolation	Double	Basic
DC Output	No isolation	/	Double	Basic
Dimming (SELV)	Double	Double	/	Basic
Housing	Basic	Basic	Basic	/

The required test voltages to comply with the Electric Strength test (a.k.a. the 'hi-pot test') of (EN IEC 60598-1:2021, §10.2.2 ):

	AC Input	DC Output	Dimming (SELV)	Housing
AC Input	/	No isolation	3920Vac	1960Vac
DC Output	No isolation	/	4400Vac	2200Vac
Dimming (SELV)	3920Vac	4400Vac	/	1960Vac
Housing	1960Vac	2200Vac	1960Vac	/

#### 4. Numbers of driver per MCB

Power Grid[Vac]	Inrush peak[A]	Duration of 50 % - 50 %[us]
220	7.45	4520
277	9.7	4480
400	13.6	4480
480	16.4	4480

Number of units per MCB	@ 220 Vac	@ 277Vac	@ 400 Vac (3-phase)	@ 480 Vac (3-phase)
B10	1	1	1+1+1	1+1+1
B16	2	2	2+2+2	2+2+2
B20	2	3	2+2+2	3+3+3
B25	3	4	3+3+3	4+4+4
C10	1	2	1+1+1	2+2+2
C16	2	3	2+2+2	3+3+3
C20	3	4	3+3+3	4+4+4
C25	4	5	4+4+4	5+5+5
D10	1	2	1+1+1	2+2+2
D16	3	3	3+3+3	3+3+3
D20	3	4	3+3+3	4+4+4
D25	4	5	4+4+4	5+5+5

Inventronics is committed to concurrent engineering with our customers to develop the world's most reliable drivers for the toughest applications. Please contact us with any comments, questions, or concerns at: <https://www.inventronics-co.com/technical-support/>.

#### Disclaimer

This note is for reference only. It is the responsibility of the customer to thoroughly analyze all aspects of the customers' proposed application for the products. The customer is solely responsible for making the final selection of the product(s) to be used and to assure that all performance and safety requirements of the application are satisfied. Inventronics makes no representation or warranty as to the completeness or accuracy of the information contained herein. The products and specifications set forth in this document are subject to change without notice and Inventronics disclaims any and all liability for such changes.